

L



SISTEMAS MODULARES PARA CABINES SANITÁRIAS / SANITARY BOOTH HARDWARE / HERRAJES PARA CABINAS SANITÁRIAS.

A JNF TEM UMA GAMA COMPLETA DE FERRAGENS EM AÇO INOXIDÁVEL PARA A CONSTRUÇÃO DE MÓDULOS SANITÁRIOS OU CABINES EM PAINÉIS HPL (TERMOLAMINADO DE ALTA PRESSÃO).

JNF HAS A COMPLETE RANGE OF STAINLESS STEEL HARDWARE FOR THE CONSTRUCTION OF SANITARY MODULES OR CABINS IN HPL PANELS (HIGH PRESSURE LAMINATE).

JNF DISPONE DE UNA COMPLETA GAMA DE HERRAJES EN ACERO INOXIDABLE PARA LA CONSTRUCCIÓN DE MÓDULOS SANITARIOS O CABINAS EN PANELES HPL (LAMINADO DE ALTA PRESIÓN).

SISTEMAS MODULARES PARA CABINES SANITÁRIAS / SANITARY BOOTH HARDWARE / HERRAJES PARA CABINAS SANITÁRIAS.

A JNF tem uma gama completa de ferragens em aço inoxidável para a construção de módulos sanitários ou cabines em painéis HPL (termolaminado de alta pressão). As ferragens são fabricadas em aço inoxidável EN 1.4301/AISI 304 e EN 1.4401/AISI 316 com acabamento satinado.

De forma a adaptar estes sistemas a qualquer tipo de decoração de interiores, as ferragens podem ser produzidas com um acabamento superficial de PVD TITANIUM (Physical Vapor Deposition), permitindo adicionar um acabamento de cor (preto, cobre e dourado), para além de aumentar a resistência à corrosão e aos riscos. Todas as ferragens são aplicáveis a painéis HPL (termolaminado de alta pressão) de 13mm ou 10mm de espessura. A estrutura aérea de estabilização dos painéis pode ser tubular de Ø19mm, quadrada 20x20mm ou em perfis de alumínio.

JNF has a complete range of stainless steel hardware for the construction of sanitary modules or cabins in HPL panels (high pressure laminate). The fittings are made of stainless steel EN 1.4301/AISI 304 and EN 1.4401/AISI 316 with satin finish.

In order to adapt these systems to any type of interior decoration, the fittings can be produced with a PVD TITANIUM (Physical Vapor Deposition) surface finish, allowing the addition of a color finish to the hardware (black, copper and gold), in addition to increase corrosion and scratch resistance.

All hardware is applicable to 13mm or 10mm thick HPL (High Pressure Laminate) panels.

The aerial stabilizing structure of the panels can be tubular Ø19mm and Ø25mm, square 20x20mm or in aluminum profiles.

JNF dispone de una completa gama de herrajes en acero inoxidable para la construcción de módulos sanitarios o cabinas en paneles HPL (laminado de alta presión).

Los accesorios son de acero inoxidable EN 1.4301/AISI 304 y EN 1.4401/AISI 316 con acabado satinado.

Para adaptar estos sistemas a cualquier tipo de decoración interior, los herrajes se pueden fabricar con un acabado superficial PVD TITANIO (Physical Vapor Deposition), que permite añadir un acabado de color (negro, cobre y oro), además de para aumentar la resistencia a la corrosión y al rayado.

Todo el hardware es aplicable a paneles HPL (laminado de alta presión) de 13mm o 10mm de espesor.

La estructura estabilizadora aérea de los paneles puede ser tubular de Ø19mm y Ø25mm, cuadrada de 20x20mm o en perfiles de aluminio.



HIGH PRESSURE LAMINATES /
 TERMOLAMINADO DE ALTA PRESSÃO
 FENÓLICO /



SISTEMA MODULAR Ø19mm PARA CABINES HPL /
 MODULAR SYSTEM Ø19mm FOR HPL BOOTH /
 SISTEMA MODULAR Ø19mm PARA CABINAS HPL /



REGULAMENTOS DE DISCRIMINAÇÃO POR DEFICIÊNCIA (DDA) /
 DISABILITY DISCRIMINATION ACT (DDA) /
 NORMATIVA SOBRE DISCRIMINACIÓN POR DISCAPACIDAD.



SISTEMA MODULAR 20X20mm PARA CABINES HPL /
 MODULAR SYSTEM 20X20mm FOR HPL BOOTH /
 SISTEMA MODULAR 20X20mm PARA CABINAS HPL /



SISTEMA MODULAR EM PERFIL PARA CABINES HPL /
 PROFILE MODULAR SYSTEM FOR HPL CABINS /
 SISTEMA MODULAR DE PERFILES PARA CABINAS HPL /

A fixação, é um ponto crucial na dobradiça, recomendamos o uso de parafusos em aço inox em todas as dobradiças. Caso se utilizem parafusos de outros materiais, pode originar um ponto indutor de corrosão. Onde comprometerá a longevidade da dobradiça.

Fixing is a crucial point on the hinge, we recommend using stainless steel screws on all hinges. If other screws made of other materials are used, this may lead to a corrosion-inducing point. Where it will compromise the longevity of the hinge.

La fijación es un punto crucial en la bisagra, recomendamos usar tornillos de acero inoxidable en todas las bisagras. Si se utilizan tornillos de otros materiales, esto puede conducir a un punto de inducción a la corrosión. Donde comprometerá la longevidad de la bisagra.

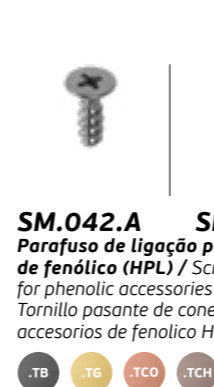

SM.042.A SM.042.B
 Parafuso de ligação para acessórios de fenólico (HPL) / Screw connection for phenolic accessories (HPL) / Tornillo pasante de conexión para accesorios de fenólico HPL.

.TB .TG .TCO .TCH



SM.040
 Parafuso de ligação para acessórios de fenólico / Screw connection for phenolic accessories / Tornillo pasante de conexión para accesorios de fenólico.

.TB .TG .TCO .TCH



SM.041
 Parafuso de ligação para acessórios de fenólico / Screw connection for phenolic accessories / Tornillo pasante de conexión para accesorios de fenólico.

.TB .TG .TCO .TCH



SM.042.E SM.042.F
 Parafuso e bucha de nylon / Screw and nylon plug / Tornillo e taco de nylon.

.TB .TG .TCO .TCH

SISTEMAS MODULARES PARA CABINES SANITÁRIAS / SANITARY BOOTH HARDWARE / HERRAJES PARA CABINAS SANITÁRIAS.



254

Solução com ferragens de secção redonda com Ø19mm. Garantindo a estabilidade necessária, mas com menos impacto que as ferragens tradicionais. Aliado ao tubo mais discreto, a possibilidade de ter todas as soluções com acabamentos TITANIUM PVD em preto, dourado e cobre permite, a quem projeta, uma liberdade para poder combinar com as diversas cores e acabamentos do HPL.

Solution with Ø19mm round section fittings. Guaranteeing the necessary stability, but with less impact than traditional hardware. Together with the more discreet tube, the possibility of having all the solutions with PVD TITANIUM finishes in black, gold and copper gives the designer the freedom to combine them with the various colours and finishes of HPL.

Solución con accesorios de sección redonda de Ø19mm. Garantizando la estabilidad necesaria, pero con menos impacto que los herrajes tradicionales. Junto con el tubo más discreto, la posibilidad de disponer de todas las soluciones con acabados TITANIUM PVD en negro, oro y cobre da al diseñador la libertad de combinarlas con los distintos colores y acabados del HPL.



260

Solução com ferragens tubulares de secção quadrada de 20x20mm, elemento inovador nas cabines fenólicas. Este sistema permite que as ferragens de fixação aéreas dos painéis fique oculto pelo exterior, criando uma solução mais "clean" que o tradicional. Além disso, a possibilidade de ter todas as soluções com acabamentos TITANIUM PVD em preto, dourado e cobre permite a quem projeta uma liberdade para poder combinar com as diversas cores e acabamentos do HPL.

Solution with tubular fittings with a square section of 20x20mm, an innovative element in the phenolic cabins. This system allows the overhead panel hardware to be hidden from the outside, creating a "clean" solution than the traditional one. Together with the more discreet tube, the possibility of having all the solutions with PVD TITANIUM finishes in black, gold and copper gives the designer the freedom to combine them with the various colours and finishes of HPL.

Solución con herrajes tubulares de sección cuadrada de 20x20mm, un elemento innovador en las cabinas fenólicas. Este sistema permite ocultar los herrajes de los paneles superiores desde el exterior, creando una solución más "clean" que la tradicional. Junto con el tubo más discreto, la posibilidad de disponer de todas las soluciones con acabados TITANIUM PVD en negro, oro y cobre da al diseñador la libertad de combinarlas con los distintos colores y acabados del HPL.



266

Solução com sistema de perfis de alumínio que garante a fixação entre painéis, à parede e ao teto. Esta solução foi desenvolvida para facilitar a instalação, tornando-a mais rápida e eficiente. O sistema "profile" permite que visualmente exista uma linha que liga todo o sistema. Para o pavimento foi desenvolvido um sistema com linhas retas, semelhante ao perfil aéreo, mas produzido em aço inoxidável com base em compósito de forma a garantir a resistência a agentes químicos utilizados na limpeza.

Solution with an aluminium profile system that ensures fastening between panels, to the wall and to the ceiling. This solution was developed to facilitate the installation, making it quicker and more efficient. The "profile" system allows a visual line that connects the whole system. For the floor, a system with straight lines was developed, similar to the overhead profile, but produced in stainless steel with a composite base in order to guarantee resistance to chemical agents used for cleaning.

Solución con un sistema de perfiles de aluminio que asegura la fijación entre paneles, a la pared y al techo. Esta solución se ha desarrollado para facilitar la instalación, haciéndola más rápida y eficaz. El sistema de "perfiles" permite que exista una línea visual que conecta todo el sistema. Para el suelo, se desarrolló un sistema de líneas rectas, similar al perfil superior, pero producido en acero inoxidable con una base de material compuesto para garantizar la resistencia a los agentes químicos utilizados para la limpieza.



270

Sistema para cabines sanitárias especialmente desenvolvido para pessoas com mobilidade reduzida. Sistema de porta de correr para painéis fenólicos de 13mm. O sistema de fecho está preparado para utilizadores com mobilidade reduzida e um sistema de segurança que permite desbloquear o fecho pelo exterior em caso de qualquer emergência.

System for sanitary cabinets specially designed for disabled people. Sliding door system for phenolic panels with 13mm. The lock system is ready for users with reduced mobility and it's provided with a security system to unlock the system from the outside in case of any emergency.

Sistema para cabinas sanitarias especialmente diseñado para personas con movilidad reducida. Sistema de puertas correderas de paneles fenólicos con 13mm. El sistema de cierre está valido para los usuarios con movilidad reducida, tiene un sistema de seguridad para desbloquear el sistema por el exterior en caso de cualquier emergencia.

SISTEMAS MODULARES PARA CABINES SANITÁRIAS / SANITARY BOOTH HARDWARE / HERRAJES PARA CABINAS SANITÁRIAS.

SOLUÇÃO COM FERRAGENS DE SECÇÃO REDONDA COM Ø19MM. GARANTINDO A ESTABILIDADE NECESSÁRIA, MAS COM MENOS IMPACTO QUE AS FERRAGENS TRADICIONAIS. ALIADO AO TUBO MAIS DISCRETO, A POSSIBILIDADE DE TER TODAS AS SOLUÇÕES COM ACABAMENTOS TITANIUM PVD EM PRETO, DOURADO E COBRE PERMITE A QUEM PROJETA UMA LIBERDADE PARA PODER COMBINAR COM AS DIVERSAS CORES E ACABAMENTOS DO HPL.

SOLUTION WITH Ø19MM ROUND SECTION FITTINGS. GUARANTEEING THE NECESSARY STABILITY, BUT WITH LESS IMPACT THAN TRADITIONAL HARDWARE. TOGETHER WITH THE MORE DISCREET TUBE, THE POSSIBILITY OF HAVING ALL THE SOLUTIONS WITH PVD TITANIUM FINISHES IN BLACK, GOLD AND COPPER GIVES THE DESIGNER THE FREEDOM TO COMBINE THEM WITH THE VARIOUS COLOURS AND FINISHES OF HPL.

SOLUCIÓN CON ACCESORIOS DE SECCIÓN REDONDA DE Ø19MM. GARANTIZANDO LA ESTABILIDAD NECESARIA, PERO CON MENOS IMPACTO QUE LOS HERRAJES TRADICIONALES. JUNTO CON EL TUBO MÁS DISCRETO, LA POSIBILIDAD DE DISPONER DE TODAS LAS SOLUCIONES CON ACABADOS TITANIUM PVD EN NEGRO, ORO Y COBRE DA AL DISEÑADOR LA LIBERTAD DE COMBINARLAS CON LOS DISTINTOS COLORES Y ACABADOS DEL HPL.



Ø19
mm

SISTEMAS MODULARES PARA CABINES SANITÁRIAS / SANITARY BOOTH HARDWARE / HERRAJES PARA CABINAS SANITÁRIAS.



ACABAMENTOS ESPECIAIS EM AÇO INOX REVESTIDO A PVD TITÂNIO

Este acabamento é conseguido pela tecnologia PVD (Physical Vapor Deposition). É um processo não galvânico, não poluente, amplamente utilizado na indústria da relojoaria.

Trata-se dum acabamento de excepcional qualidade, conferindo ao produto final uma dureza adicional e uma resistência à corrosão elevadíssima.

.TB. PVD TITANIUM BLACK

.TG PVD TITANIUM GOLD

.TCO PVD TITANIUM COPPER

.TN. PVD TITANIUM NATURAL

SPECIAL FINISH ON STAINLESS STEEL TITANIUM PVD COATED

This finish is achieved by PVD technology (Physical Vapor Deposition). It is a non galvanic, pollution free process, widely used in the watchmaking industry.

This is an exceptionally high quality finish, giving the final product an additional hardness and a very high corrosion resistance.

ACABADOS ESPECIALES EN ACERO INOXIDABLE EN TITANIO PVD

Este acabado se consigue mediante la tecnología PVD (Physical Vapor Deposition). Es un proceso no galvánico, no contaminante, muy utilizado en la industria relojera.

Se trata de un acabado de excepcional calidad, que aporta al producto final una dureza adicional y una altísima resistencia a la corrosión.

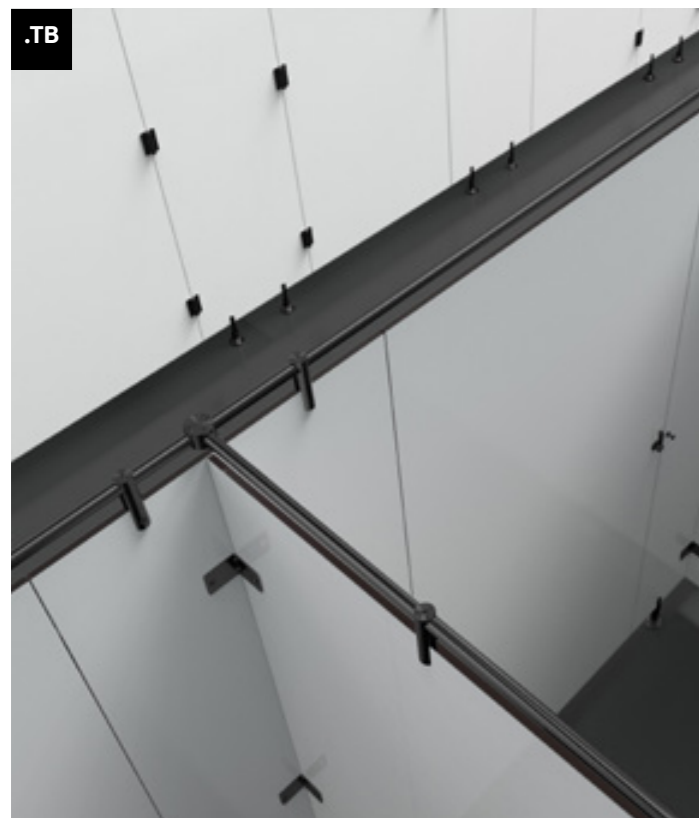
 Ø19
 mm

.TB
 PVD TITANIUM BLACK + EN 1.4301
 Satinado / Satin / Satin

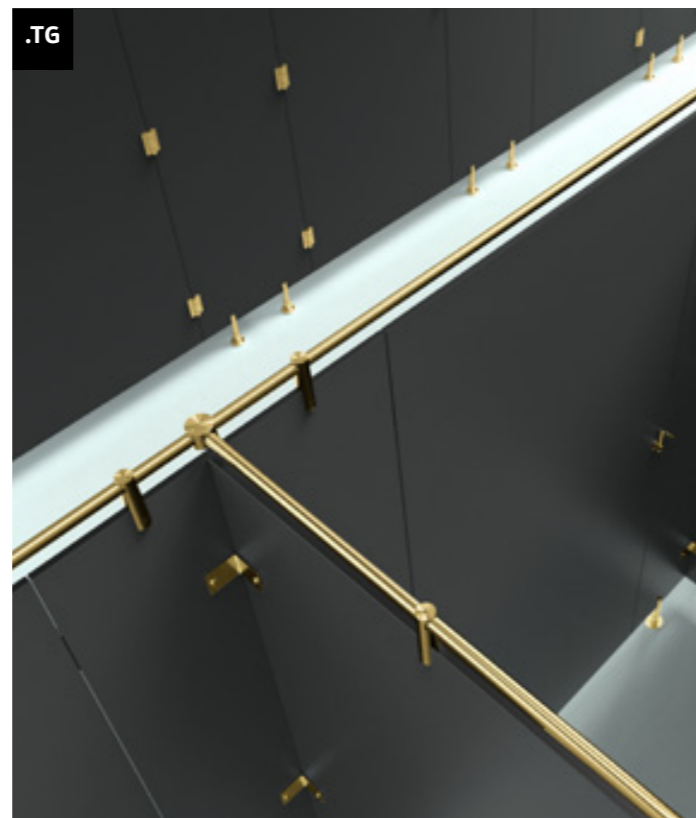

.TG
 PVD TITANIUM GOLD + EN 1.4301
 Satinado / Satin / Satin

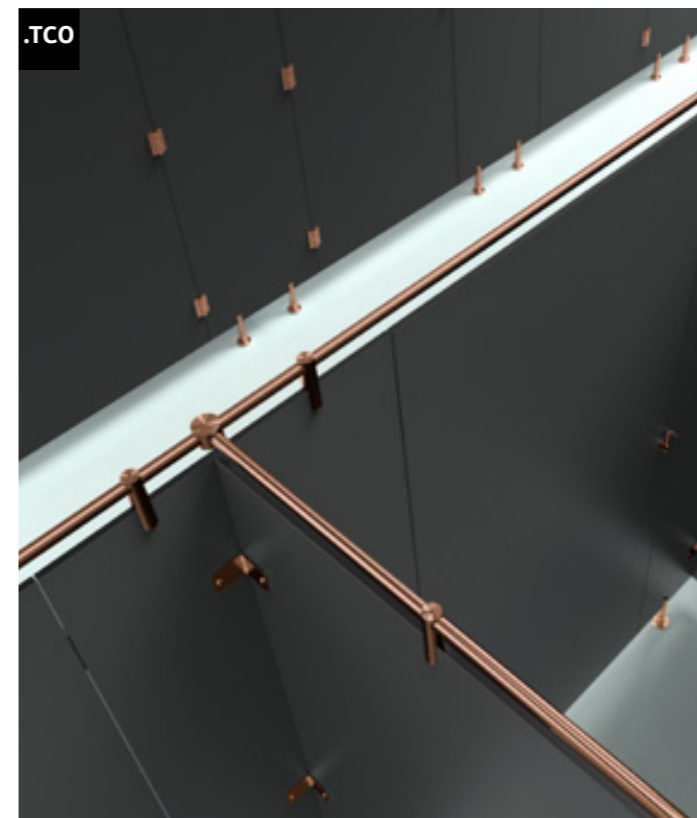

.TCO
 PVD TITANIUM COPPER + EN 1.4301
 Satinado / Satin / Satin

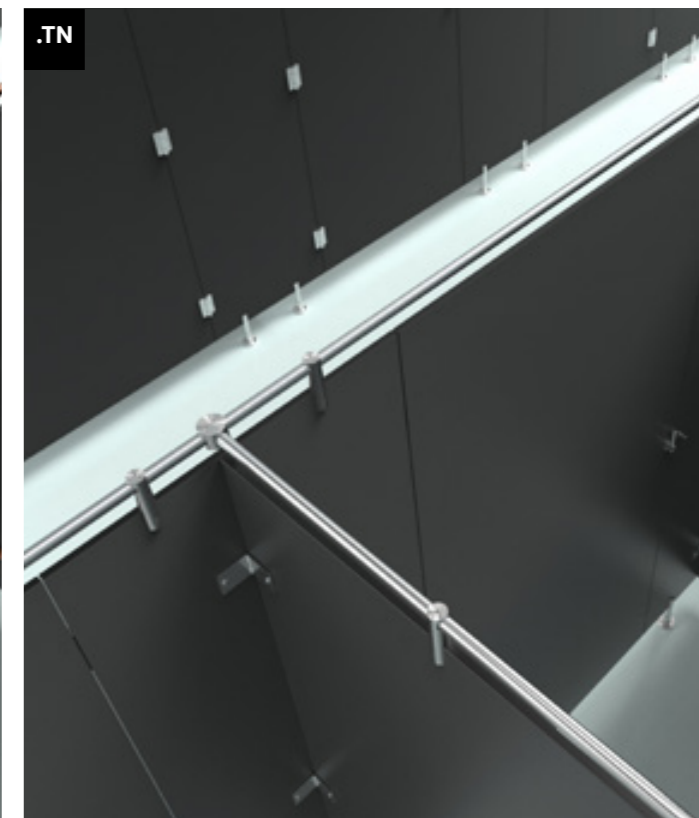

.TN
 PVD TITANIUM NATURAL + EN 1.4301
 Satinado / Satin / Satin

SISTEMAS MODULARES PARA CABINES SANITÁRIAS /
SANITARY BOOTH HARDWARE /
HERRAJES PARA CABINAS SANITÁRIAS.

Ø19
mm



<p>1</p>  <p>SM.017</p>	 <p>SM.017.XL</p>	<p>2</p>  <p>SM.006.B</p>	 <p>SM.005.E / SM.005.F</p>	 <p>SM.005.B / SM.005.C</p>
<p>3</p>  <p>SM.031</p>	 <p>SM.060</p>	 <p>SM.030</p>	 <p>SM.029</p>	 <p>SM.035</p>
<p>4</p>  <p>IN.75.051.D</p>	 <p>IN.75.050.D</p>	 <p>IN.75.042</p>	 <p>IN.75.041</p>	 <p>IN.75.040</p>
<p>5</p>  <p>IN.14.010</p>	 <p>IN.14.546 / IN.14.546.F</p>	 <p>IN.14.541</p>	 <p>SM.008</p>	
<p>6</p>  <p>SM.010.A.19</p>	 <p>SM.032.19 / SM.033.19</p>	 <p>SM.022</p>	 <p>SM.002.19</p>	 <p>SM.011.19</p>
<p>7</p>  <p>SM.065</p>	 <p>SM.004</p>	 <p>SM.024</p>	 <p>SM.034</p>	 <p>SM.034</p>

SISTEMAS MODULARES PARA CABINES SANITÁRIAS 20X20 / SANITARY BOOTH HARDWARE 20X20 / HERRAJES PARA CABINAS SANITÁRIAS 20X20.

SOLUÇÃO COM FERRAGENS TUBULARES DE SECÇÃO QUADRADA DE 20X20MM, ELEMENTO INOVADOR NAS CABINES FENÓLICAS. ESTE SISTEMA PERMITE QUE AS FERRAGENS DE FIXAÇÃO AÉREAS DOS PAINÉIS FIQUE OCULTO PELO EXTERIOR, CRIANDO UMA SOLUÇÃO "CLEAN" QUE O TRADICIONAL. ALIADO AO TUBO MAIS DISCRETO, A POSSIBILIDADE DE TER TODAS ASA SOLUÇÕES COM ACABAMENTOS TITANIUM PVD EM PRETO, DOURADO E COBRE PERMITE A QUEM PROJETA UMA LIBERDADE PARA PODER COMBINAR COM AS DIVERSAS CORES E ACABAMENTOS DO HPL.

SOLUTION WITH TUBULAR FITTINGS WITH A SQUARE SECTION OF 20X20MM, AN INNOVATIVE ELEMENT IN THE PHENOLIC CABINS. THIS SYSTEM ALLOWS THE OVERHEAD PANEL HARDWARE TO BE HIDDEN FROM THE OUTSIDE, CREATING A "CLEAN" SOLUTION THAN THE TRADITIONAL ONE. TOGETHER WITH THE MORE DISCREET TUBE, THE POSSIBILITY OF HAVING ALL THE SOLUTIONS WITH PVD TITANIUM FINISHES IN BLACK, GOLD AND COPPER GIVES THE DESIGNER THE FREEDOM TO COMBINE THEM WITH THE VARIOUS COLOURS AND FINISHES OF HPL.

SOLUCIÓN CON HERRAJES TUBULARES DE SECCIÓN CUADRADA DE 20X20MM, UN ELEMENTO INNOVADOR EN LAS CABINAS FENÓLICAS. ESTE SISTEMA PERMITE OCULTAR LOS HERRAJES DE LOS PANELES SUPERIORES DESDE EL EXTERIOR, CREAMDO UNA SOLUCIÓN MÁS "CLEAN" QUE LA TRADICIONAL. JUNTO CON EL TUBO MÁS DISCRETO, LA POSIBILIDAD DE DISPONER DE TODAS LAS SOLUCIONES CON ACABADOS TITANIUM PVD EN NEGRO, ORO Y COBRE DA AL DISEÑADOR LA LIBERTAD DE COMBINARLAS CON LOS DISTINTOS COLORES Y ACABADOS DEL HPL.



20x20
mm

SISTEMAS MODULARES PARA CABINES SANITÁRIAS 20X20mm/ SANITARY BOOTH HARDWARE 20X20mm / HERRAJES PARA CABINAS SANITÁRIAS 20X20mm.



ACABAMENTOS ESPECIAIS EM AÇO INOX REVESTIDO A PVD TITÂNIO

Este acabamento é conseguido pela tecnologia PVD (Physical Vapor Deposition). É um processo não galvânico, não poluente, amplamente utilizado na indústria da relojoaria.

Trata-se dum acabamento de excepcional qualidade, conferindo ao produto final uma dureza adicional e uma resistência à corrosão elevadíssima.

.TB. PVD TITANIUM BLACK

.TG PVD TITANIUM GOLD

.TCO PVD TITANIUM COPPER

.TN. PVD TITANIUM NATURAL

SPECIAL FINISH ON STAINLESS STEEL TITANIUM PVD COATED

This finish is achieved by PVD technology (Physical Vapor Deposition). It is a non galvanic, pollution free process, widely used in the watchmaking industry.

This is an exceptionally high quality finish, giving the final product an additional hardness and a very high corrosion resistance.

ACABADOS ESPECIALES EN ACERO INOXIDABLE EN TITANIO PVD

Este acabado se consigue mediante la tecnología PVD (Physical Vapor Deposition). Es un proceso no galvánico, no contaminante, muy utilizado en la industria relojera.

Se trata de un acabado de excepcional calidad, que aporta al producto final una dureza adicional y una altísima resistencia a la corrosión.



.TB
PVD TITANIUM BLACK + EN 1.4301
Satinado / Satin / Satin

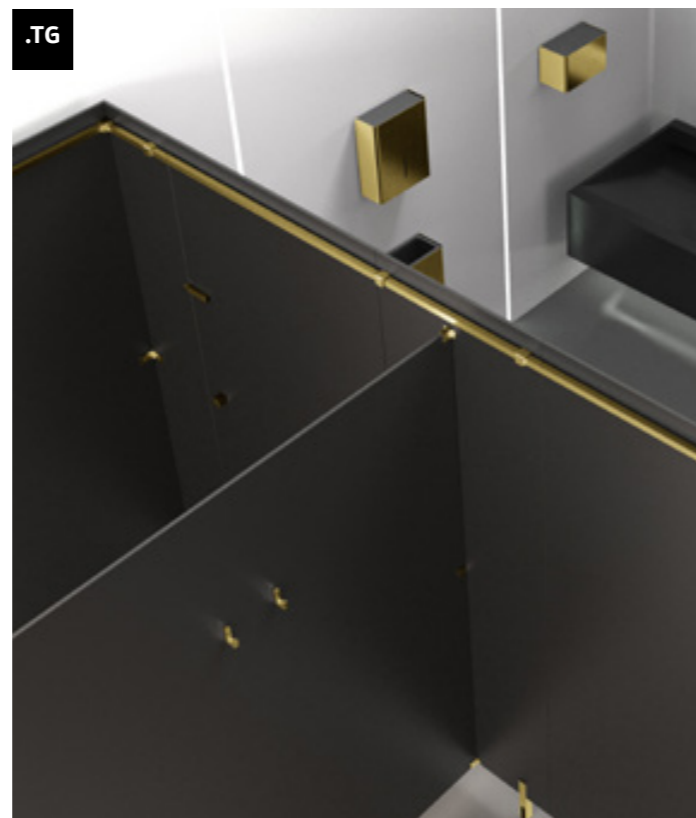

.TG
PVD TITANIUM GOLD + EN 1.4301
Satinado / Satin / Satin



.TCO
PVD TITANIUM COPPER + EN 1.4301
Satinado / Satin / Satin



.TN
PVD TITANIUM NATURAL + EN 1.4301
Satinado / Satin / Satin

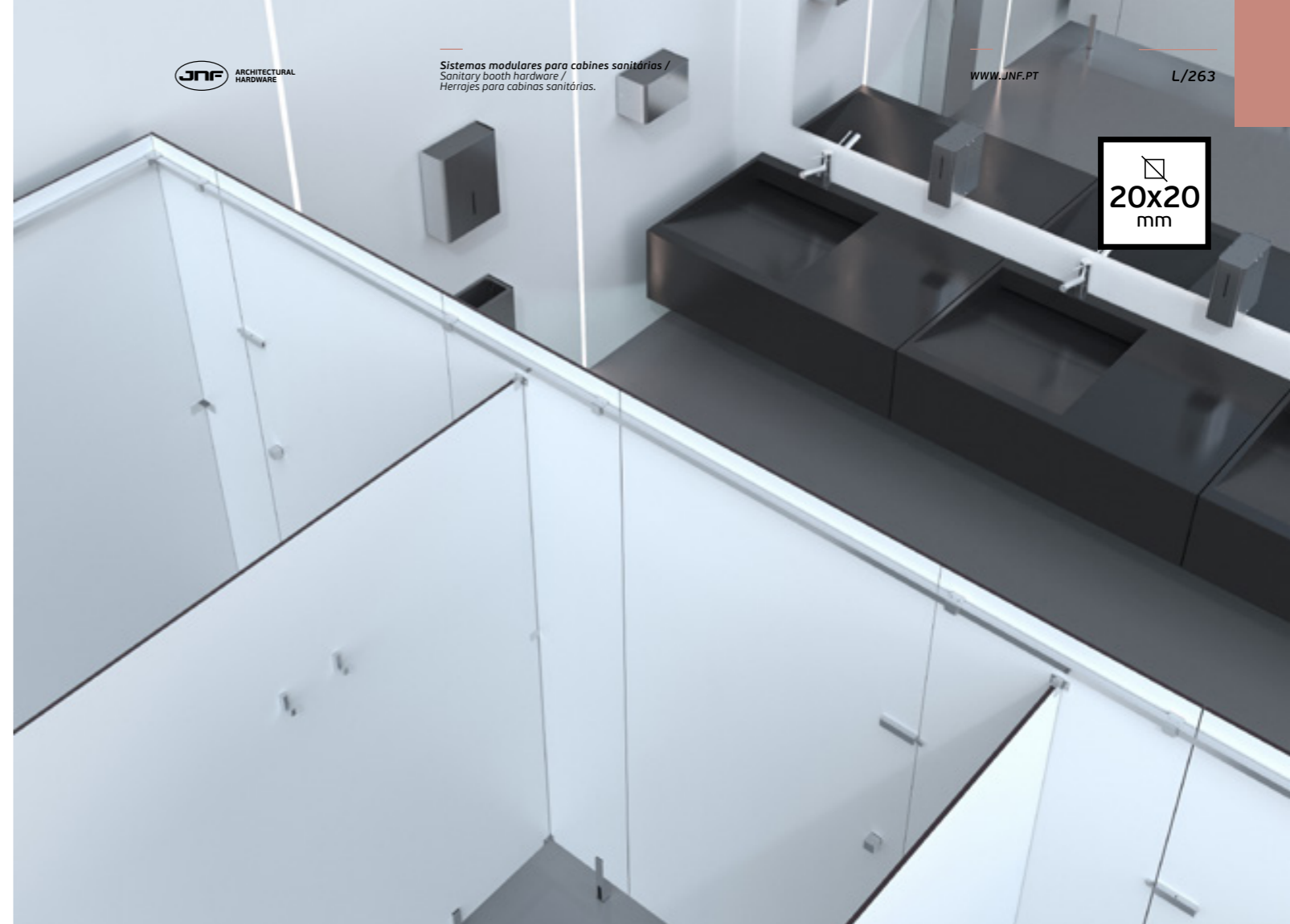

SISTEMAS MODULARES PARA CABINES SANITÁRIAS 20X20 /
SANITARY BOOTH HARDWARE 20X20 /
HERRAJES PARA CABINAS SANITÁRIAS 20X20.

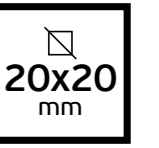

1		2			
	SM.070		SM.006.B	SM.005.E / SM.005.F	SM.005.B / SM.005.C
3					
	SM.035	SM.031	SM.060	SM.030	SM.029
4					
	IN.75.051.D	IN.75.050.D	IN.75.042	IN.75.041	IN.75.040
5					
	IN.14.010	IN.14.546 / IN.14.546.F	IN.14.541	SM.008	
6					
	SM.010.Q.20	SM.062	SM.063	SM.064.D	SM.064.E
7					
	SM.065	SM.004	SM.024	SM.034	SM.034

SISTEMAS MODULARES PARA CABINES SANITÁRIAS - PROFILE / SANITARY BOOTH HARDWARE - PROFILE / HERRAJES PARA CABINAS SANITÁRIAS - PROFILE.

profile

SOLUÇÃO COM SISTEMA DE PERFIS DE ALUMÍNIO QUE GARANTE A FIXAÇÃO ENTRE PAINÉIS, À PAREDE E AO TETO. ESTA SOLUÇÃO FOI DESENVOLVIDA PARA FACILITAR A INSTALAÇÃO, TORNANDO-A MAIS RÁPIDA E EFICIENTE. O SISTEMA "PROFILE" PERMITE QUE VISUALMENTE EXISTA UMA LINHA QUE LIGA TODO O SISTEMA. PARA O PAVIMENTO FOI DESENVOLVIDO UM SISTEMA COM LINHAS RETAS, SEMELHANTE AO PERFIL AÉREO, MAS PRODUZIDO EM AÇO INOXIDÁVEL COM BASE EM COMPÓSITO DE FORMA A GARANTIR A RESISTÊNCIA A AGENTES QUÍMICOS UTILIZADOS NA LIMPEZA.

SOLUTION WITH AN ALUMINIUM PROFILE SYSTEM THAT ENSURES FASTENING BETWEEN PANELS, TO THE WALL AND TO THE CEILING. THIS SOLUTION WAS DEVELOPED TO FACILITATE THE INSTALLATION, MAKING IT QUICKER AND MORE EFFICIENT. THE "PROFILE" SYSTEM ALLOWS A VISUAL LINE THAT CONNECTS THE WHOLE SYSTEM. FOR THE FLOOR, A SYSTEM WITH STRAIGHT LINES WAS DEVELOPED, SIMILAR TO THE OVERHEAD PROFILE, BUT PRODUCED IN STAINLESS STEEL WITH A COMPOSITE BASE IN ORDER TO GUARANTEE RESISTANCE TO CHEMICAL AGENTS USED FOR CLEANING.

SOLUCIÓN CON UN SISTEMA DE PERFILES DE ALUMINIO QUE ASEGURA LA FIJACIÓN ENTRE PANELES, A LA PARED Y AL TECHO. ESTA SOLUCIÓN SE HA DESARROLLADO PARA FACILITAR LA INSTALACIÓN, HACIÉNDOLA MÁS RÁPIDA Y EFICAZ. EL SISTEMA DE "PERFILES" PERMITE QUE EXISTA UNA LÍNEA VISUAL QUE CONECTA TODO EL SISTEMA. PARA EL SUELO, SE DESARROLLÓ UN SISTEMA DE LÍNEAS RECTAS, SIMILAR AL PERFIL SUPERIOR, PERO PRODUCIDO EN ACERO INOXIDABLE CON UNA BASE DE MATERIAL COMPUESTO PARA GARANTIZAR LA RESISTENCIA A LOS AGENTES QUÍMICOS UTILIZADOS PARA LA LIMPIEZA.

SISTEMAS MODULARES PARA CABINES SANITÁRIAS - PROFILE /
SANITARY BOOTH HARDWARE - PROFILE /
HERRAJES PARA CABINAS SANITÁRIAS - PROFILE.



profile

<p>1</p>  <p>SM.070</p>	<p>2</p>  <p>SM.006.B</p>	 <p>SM.005.E / SM.005.F</p>	 <p>SM.005.B / SM.005.C</p>	
<p>3</p>  <p>SM.031</p>	 <p>SM.035</p>	 <p>SM.060</p>	 <p>SM.030</p>	 <p>SM.029</p>
<p>4</p>  <p>IN.75.050.D</p>	 <p>IN.75.051.D</p>	 <p>IN.75.040</p>	 <p>IN.75.041</p>	 <p>IN.75.042</p>
<p>5</p>  <p>IN.14.010</p>	 <p>IN.14.546 / IN.14.546.F</p>	 <p>IN.14.541</p>	 <p>SM.008</p>	
<p>6</p>  <p>SM.103</p>	 <p>SM.101</p>	 <p>SM.102</p>		
<p>7</p>  <p>SM.065</p>	 <p>SM.004</p>	 <p>SM.024</p>	 <p>SM.034</p>	 <p>SM.034</p>

SISTEMAS MODULARES PARA CABINES SANITÁRIAS / SANITARY BOOTH HARDWARE / HERRAJES PARA CABINAS SANITÁRIAS.

**SISTEMA PARA CABINES SANITÁRIAS
ESPECIALMENTE DESENVOLVIDO PARA
PESSOAS COM MOBILIDADE REDUZIDA.
SISTEMA DE PORTA DE CORRER PARA
PAINÉIS FENÓLICOS DE 13MM.
O SISTEMA DE FECHO ESTÁ
PREPARADO PARA UTILIZADORES
COM MOBILIDADE REDUZIDA E UM
SISTEMA DE SEGURANÇA QUE PERMITE
DESBLOQUEAR O FECHO PELO EXTERIOR
EM CASO DE QUALQUER EMERGÊNCIA. /**

SYSTEM FOR SANITARY CABINETS
SPECIALLY DESIGNED FOR DISABLED
PEOPLE.
SLIDING DOOR SYSTEM FOR PHENOLIC
PANELS WITH 13MM. THE LOCK SYSTEM
IS READY FOR USERS WITH REDUCED
MOBILITY AND IT'S PROVIDED WITH
A SECURITY SYSTEM TO UNLOCK THE
SYSTEM FROM THE OUTSIDE IN CASE OF
ANY EMERGENCY. /

SISTEMA PARA CABINAS SANITARIAS
ESPECIALMENTE DISEÑADO PARA
PERSONAS CON MOVILIDAD REDUCIDA.
SISTEMA DE PUERTAS CORREDERAS DE
PANELES FENÓLICOS CON 13MM.
EL SISTEMA DE CIERRE ESTÁ VALIDO PARA
LOS USUARIOS CON MOVILIDAD REDUCIDA,
TIENE UN SISTEMA DE SEGURIDAD
PARA DESBLOQUEAR EL SISTEMA POR
EL EXTERIOR EN CASO DE CUALQUIER
EMERGENCIA. /



sistemas modulares para cabinas sanitárias

SANITARY BOOTH HARDWARE /
HERRAJES PARA CABINAS SANITÁRIAS.



Sistema para cabinas sanitárias especialmente desenvolvido para pessoas com mobilidade reduzida.

Sistema de porta de correr para painéis fenólicos de 13mm.

O sistema de fecho está preparado para utilizadores com mobilidade reduzida e um sistema de segurança que permite desbloquear o fecho pelo exterior em caso de qualquer emergência.

System for sanitary cabinets specially designed for disabled people.

Sliding door system for phenolic panels with 13mm.

The lock system is ready for users with reduced mobility and it's provided with a security system to unlock the system from the outside in case of any emergency.

Sistema para cabinas sanitarias especialmente diseñado para personas con movilidad reducida.

Sistema de puertas correderas de paneles fenólicos con 13mm.

El sistema de cierre está válido para los usuarios con movilidad reducida, tiene un sistema de seguridad para desbloquear el sistema por el exterior en caso de cualquier emergencia.

Exemplo
Example / Ejemplo

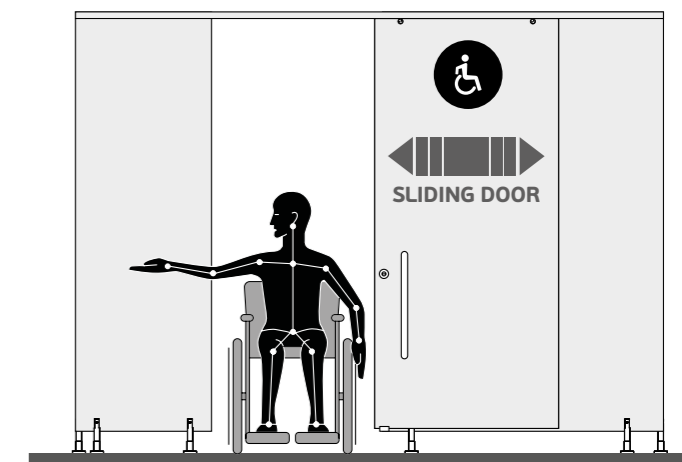
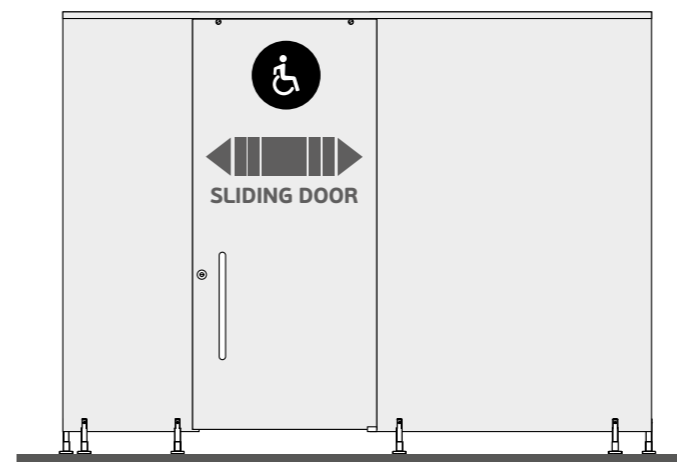

Exemplo
Example / Ejemplo

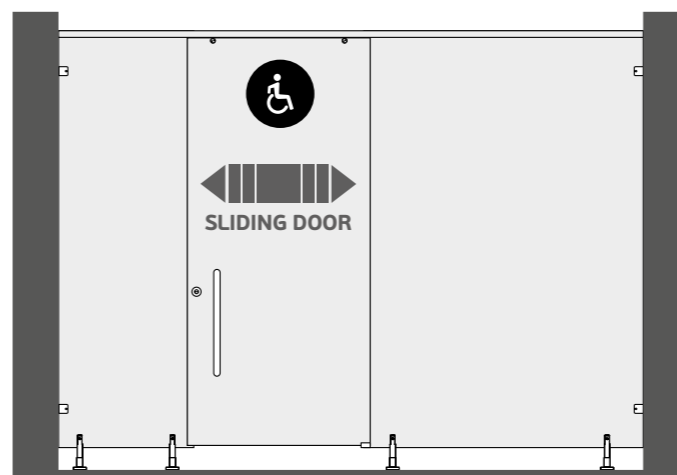

SISTEMAS MODULARES PARA CABINES SANITÁRIAS /
SANITARY BOOTH HARDWARE /
HERRAJES PARA CABINAS SANITÁRIAS.

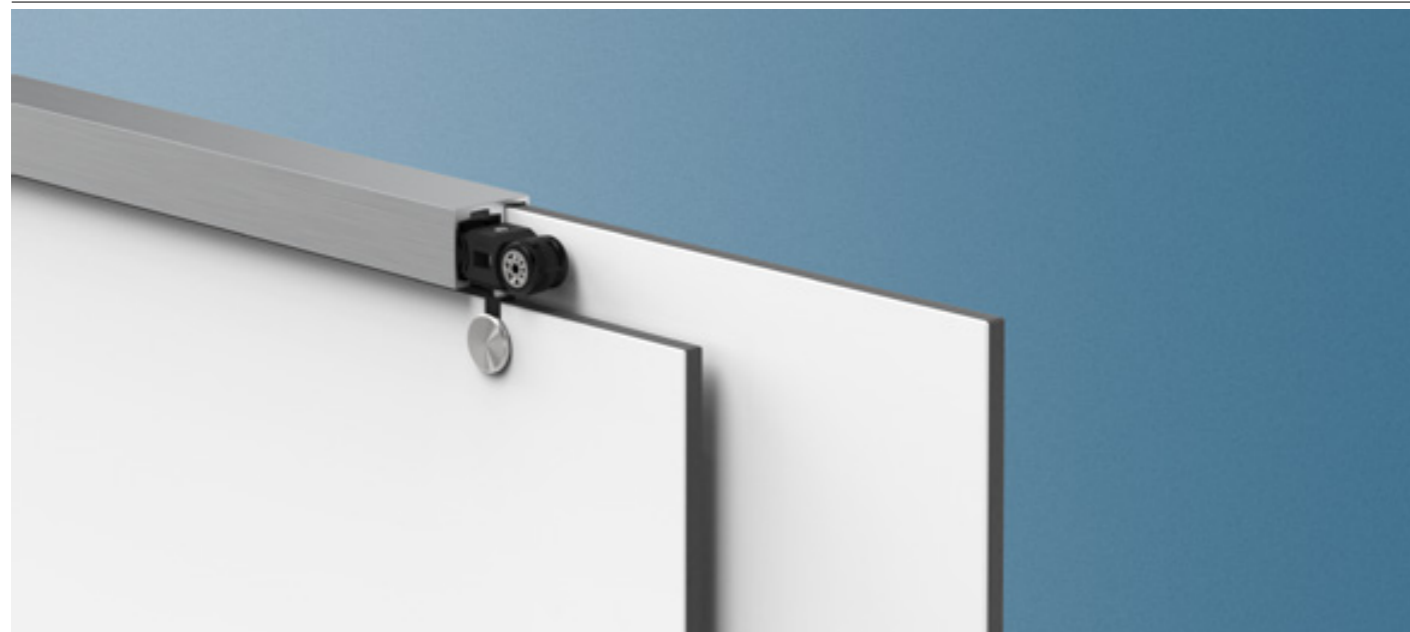

<p>1</p>  <p>SM.070</p>	 <p>SM.017</p>	 <p>SM.017.XL</p>	<p>2</p>  <p>IN.15.258</p>
<p>3</p>  <p>SM.036</p>	 <p>SM.037</p>	 <p>SM.038</p>	 <p>IN.04.110</p>
<p>4</p>  <p>IN.75.050.D</p>	 <p>IN.75.051.D</p>	 <p>IN.07.287.D.35</p> <p>VOL.1 > Cap B/422 Consultar Catálogo JNF ferragens para arquitetura, para mais modelos de assas de porta. Consult JNF catalogues architectural hardware, for more pull handles models / Consultar Catálogos JNF herrajes para arquitectura, para más modelos de manillones de puerta.</p>	
<p>5</p>  <p>IN.14.010</p>	 <p>IN.14.546 / IN.14.546.F</p>	 <p>IN.14.541</p>	 <p>SM.008</p>
<p>6</p>  <p>SM.103</p>	 <p>SM.101</p>	 <p>SM.102</p>	
<p>7</p>  <p>SM.065</p>	 <p>SM.004</p>	 <p>SM.024</p>	 <p>SM.034</p>  <p>SM.034</p>

SISTEMAS MODULARES PARA CABINES SANITÁRIAS / SANITARY BOOTH HARDWARE / HERRAJES PARA CABINAS SANITÁRIAS.

UNIVERSAL ADJUSTABLE FEET

**COMPONENTES EM CONTACTO COM O PAVIMENTO
PRODUZIDOS EM AÇO INOXIDÁVEL AISI 316,
GARANTINDO GRANDE RESISTÊNCIA AOS AGENTES
QUÍMICOS USADOS NA LIMPEZA DE PAVIMENTOS /
COMPONENTS IN CONTACT WITH THE FLOOR MADE OF
AISI 316 STAINLESS STEEL, ENSURING GREAT RESISTANCE
TO CHEMICAL AGENTS USED IN FLOOR CLEANING /
COMPONENTES EN CONTACTO CON EL SUELO FABRICADOS
EN ACERO INOXIDABLE AISI 316, GARANTIZANDO UNA
GRAN RESISTENCIA A LOS AGENTES QUÍMICOS UTILIZADOS
EN LA LIMPIEZA DE SUELOS.**

**O AJUSTE DO SUPORTE EM
ALTURA É POSSÍVEL MESMO
COM A BASE JÁ FIXA AO SOLO
E O PAINEL JÁ INSTALADO /
THE HEIGHT IT IS ADJUSTABLE
EVEN WITH THE BASE ALREADY
FIXED ON THE FLOOR AND THE
PANEL ON THE SUPPORT /
EL AJUSTE ES POSIBLE MISMO
DESPUES DE LA SUJECION
DE LA BASE AL SUELO Y DEL
PANEL EN AL SOPORTE.**

HPL HIGH PRESSURE LAMINATES /
TERMOLAMINADO DE ALTA PRESSÃO
FENÓLICO /

SM.017

**Base regulável para painel
Fixação ao solo através de uma
sólida base metálica. O ajuste
do suporte em altura é possível
mesmo com a base já fixa ao solo
e o painel já instalado /
Adjustable foot. Fixing on the floor
through a strong metallic base. The
height it is adjustable even with the
base already fixed on the floor and the
panel on the support /
Pie regulable. Sujecion al suelo
atraves de solida base metalica. El
ajuste es posible mesmo despues de
la sujecion de la base al suelo y del
panel en al soporte.**

Material: EN 1.4301/AISI 304 +
EN 1.4401 / AISI 316

Acabamento / Finish / Acabado:
satinado / satin

Opcional / Optional:
pvd titanium black (.TB); gold (.TG) /
copper (.TCO); / natural (.TN)

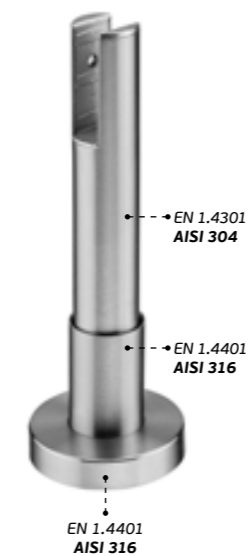
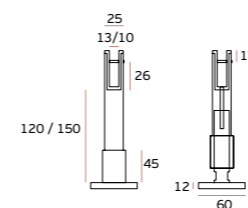

1.

2.



3.

4.



1. SM.017.TB
3. SM.017.TCO

2. SM.017.TG
4. SM.017.TN



SM.017.XL

**Base regulável para painel
Fixação ao solo através de uma
sólida base metálica. O ajuste
do suporte em altura é possível
mesmo com a base já fixa ao solo
e o painel já instalado /
Adjustable foot. Fixing on the floor
through a strong metallic base. The
height it is adjustable even with the
base already fixed on the floor and the
panel on the support /
Pie regulable. Sujecion al
suelo atraves de solida base metalica.
El ajuste es posible mesmo despues
de la sujecion de la base al suelo y del
panel en al soporte.**

Material: EN 1.4301/AISI 304 +
EN 1.4401 / AISI 316

Acabamento / Finish / Acabado:
satinado / satin

Opcional / Optional:
pvd titanium black (.TB); gold (.TG) /
copper (.TCO); / natural (.TN)

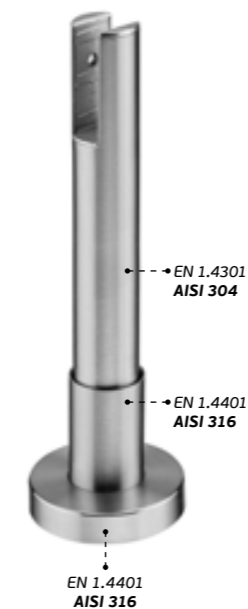
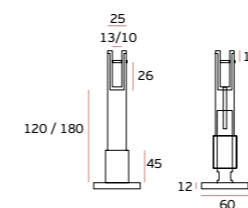

1.

2.



3.

4.



1. SM.017.XL.TB
3. SM.017.XL.TCO

2. SM.017.XL.TG
4. SM.017.XL.TN



SISTEMAS MODULARES PARA CABINES SANITÁRIAS / SANITARY BOOTH HARDWARE / HERRAJES PARA CABINAS SANITÁRIAS.

SQUARE ADJUSTABLE FEET

AJUSTÁVEL EM ALTURA POR SISTEMA NIVELADOR OCULTO, PERMITE O AJUSTE COM O PAINEL JÁ INSTALADO UTILIZANDO APENAS O PARAFUSO AFINADOR NA LATERAL DA BASE /
HEIGHT ADJUSTABLE BY CONCEALED LEVELING SYSTEM, ALLOWS ADJUSTMENT WITH THE PANEL ALREADY INSTALLED USING ONLY THE TUNER BOLT ON THE SIDE OF THE BASE /
AJUSTABLE EN ALTURA POR SISTEMA NIVELADOR OCULTO, PERMITE EL AJUSTE CON EL PANEL YA INSTALADO UTILIZANDO SÓLO LO TORNILLO AFINADOR EN LA LATERAL DE LA BASE.

A BASE DE APOIO AO PAVIMENTO EM COMPÓSITO RESISTENTE A AGENTES QUÍMICOS /
THE SUPPORT BASE FOR THE FLOOR IN MADE IN COMPOSITE RESISTANT TO CHEMICAL AGENTS /
LA BASE DE APOYO AL PAVIMENTO EN COMPOSITE RESISTENTE A AGENTES QUÍMICOS.

HPL HIGH PRESSURE LAMINATES /
TERMOLAMINADO DE ALTA PRESSÃO
FENÓLICO /

SM.070

Pé quadrada para painel HPL 13mm.
Ajustável em altura por sistema nivelador oculto, permite o ajuste com o painel já instalado utilizando apenas o parafuso afinador na lateral da base. Todas as fixações ficam ocultas. A base de apoio ao pavimento em compósito resistente a agentes químicos
/ Square base for panel HPL 13mm thickness.
Height adjustable by concealed leveling system, allows adjustment with the panel already installed using only the tuner bolt on the side of the base. All the fixings are hidden. The support base for the floor in made in composite resistant to chemical agents / Base cuadrada para panel HPL 13mm. Ajustable en altura por sistema nivelador oculto, permite el ajuste con el panel ya instalado utilizando sólo lo tornillo afinador en la lateral de la base. La base de apoyo al pavimento en composite resistente a agentes químicos. Todas las fijaciones quedan ocultas.

Material: EN 1.4301/AISI 304
Acabamento / Finish / Acabado:
satinado / satin
Opcional / Optional:
pvd titanium black (.TB); gold (.TG) /
copper (.TCO); / natural (.TN)

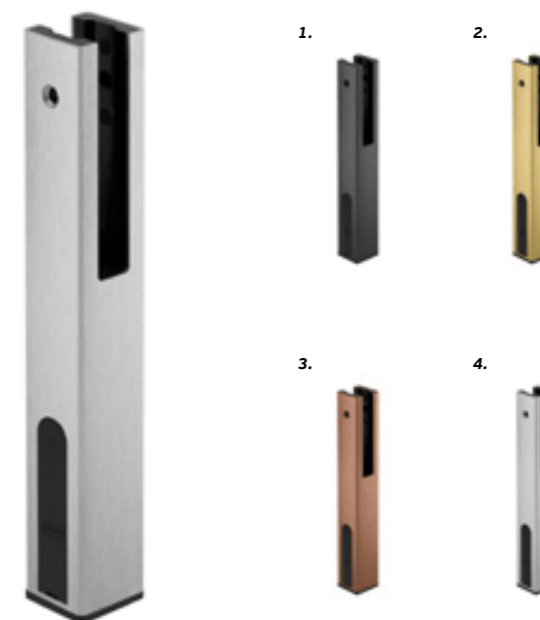
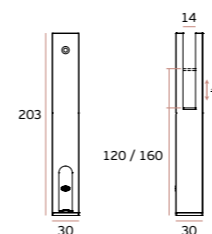

1. SM.070.TB
2. SM.070.TG
3. SM.070.TCO
4. SM.070.TN

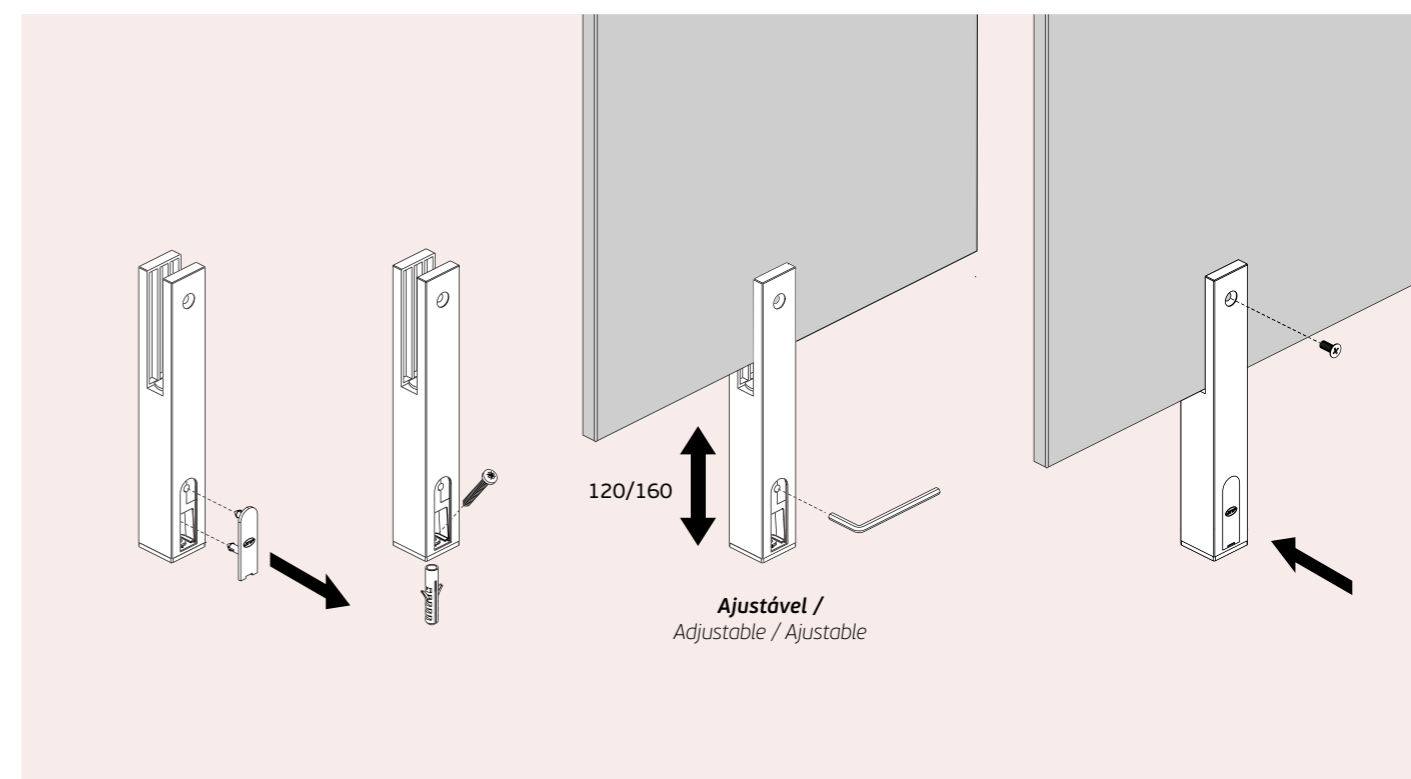

DOBRADIÇAS - PAINEL FENÓLICO (HPL)

HINGES - PHENOLIC PANEL (HPL) /
BISAGRAS - PANEL FENÓLICO (HPL)



HEAVY DUTY

ALTA CAPACIDADE DE CARGA /
BIG LOAD CAPACITY /
ALTA CAPACIDAD DE CARGA

BAIXA MANUTENÇÃO
ROLAMENTOS DE
ALTA RESISTÊNCIA /
BAJO MANTENIMIENTO
RODAMIENTOS DE
ALTA RESISTENCIA /

CLEAN DESIGN

AÇO INOX / STAINLESS STEEL /
ACERO INOX EN 1.4301 - AISI 304

ACABAMENTOS EM PVD TITÂNIO /
TITANIUM PVD FINISH /
ACABADOS DE PVD TITANIO



HPL HIGH PRESSURE LAMINATES /
TERMOLAMINADO DE ALTA PRESSÃO
FENÓLICO /

NEW

SM.006.B
Dobradiça /
Flat hinge / Bisagra plana.

Material: EN 1.4301/AISI 304
Acabamento / Finish / Acabado:
satinado / satin
Opcional / Optional: pvd titanium
black (.TB); copper (.TCO); gold (.TG)

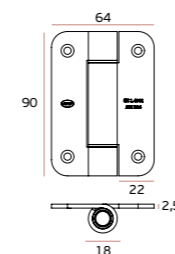

SM.042.A
Parafuso de ligação para
acessórios de fenólico (HPL)
/ Screw connection for phenolic
accessories (HPL) /
Tornillo pasante de conexión
para accesorios de fenolico HPL.



SM.006.B
EN 1.4301 / AISI 304
Satinado / Satin / Satin



SM.006.B.TB
EN 1.4301 + PVD TITANIUM BLACK
Satinado / Satin / Satin
TITANIUM BLACK



SM.006.B.TG
EN 1.4301 + PVD TITANIUM GOLD
Satinado / Satin / Satin
TITANIUM GOLD



SM.006.B.TCO
EN 1.4301 + PVD TITANIUM COPPER
Satinado / Satin / Satin
TITANIUM COPPER



SM.006.B.TN
EN 1.4301 + PVD TITANIUM NATURAL
Satinado / Satin / Satin
TITANIUM NATURAL

DOBRADIÇAS COM MOLA PARA PAINEL FENÓLICO (HPL)

HINGES WITH SPRING FOR PHENOLIC PANEL (HPL)

BISAGRAS CON MUELLE PARA PANEL FENÓLICO (HPL)

HINGE WITH COVERS

DOBRADIÇAS COM TAMPAS PARA PAINEL HPL / HINGES WITH COVERS FOR HPL PANEL / BISAGRAS CON CUBIERTAS PARA PANELES HPL

DISPONÍVEL COM MOLA PARA FECHO AUTOMÁTICO COM FORÇA AJUSTÁVEL, OU DOBRADIÇA LIVRE. / AVAILABLE WITH SPRING FOR AUTOMATIC CLOSURE WITH ADJUSTABLE FORCE, OR FREE HINGE. / DISPONIBLE CON MUELLE PARA EL CIERRE AUTOMÁTICO CON FUERZA AJUSTABLE, O BISAGRA LIBRE.



HPL HIGH PRESSURE LAMINATES /
 TERMOLAMINADO DE ALTA PRESSÃO
 FENÓLICO /

Power adjustable spring

NEW

SM.005.E Dobradiça para HPL com mola ajustável e fixações ocultas.

Parafusos incluídos / Adjustable spring hinge for HPL with concealed fixings. Screws included /
Bisagra para HPL con resorte ajustable y fijaciones ocultas. Tornillos incluidos.

Material:
 Satinado / Satin

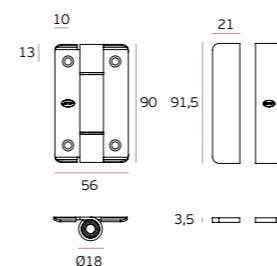

SM.042.A Parafuso de ligação para acessórios de fenólico (HPL)

/ Screw connection for phenolic accessories (HPL) / Tornillo pasante de conexión para accesorios de fenolico HPL.



SM.005.F Dobradiça para HPL com fixações ocultas.

Parafusos incluídos / Hinge for HPL with concealed fixings. Screws included /
Bisagra para HPL con fijaciones ocultas. Tornillos incluidos

Material:
 Satinado / Satin

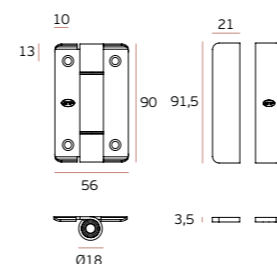

SM.042.A Parafuso de ligação para acessórios de fenólico (HPL)

/ Screw connection for phenolic accessories (HPL) / Tornillo pasante de conexión para accesorios de fenolico HPL.



DOBRADIÇAS COM MOLA PARA PAINEL FENÓLICO (HPL)

HINGES WITH SPRING FOR PHENOLIC PANEL (HPL)

BISAGRAS CON MUELLE PARA PANEL FENÓLICO (HPL)

UNIVERSAL HINGE FOR HPL

DOBRADIÇAS DISPONÍVEIS
EM 3 ACABAMENTOS, AÇO
INOXIDÁVEL SATINADO E
TITANIUM PVD PRETO E
DOURADO. /

HINGES AVAILABLE IN 3
FINISHES, SATIN-FINISHED
STAINLESS STEEL AND PVD
TITANIUM BLACK AND GOLD. /
BISAGRAS DISPONIBLES
EN 3 ACABADOS, ACERO
INOXIDABLE SATINADO Y
TITANIUM PVD NEGRO Y ORO.

DISPONÍVEL COM MOLA
PARA FECHO AUTOMÁTICO
COM FORÇA AJUSTÁVEL,
OU DOBRADIÇA LIVRE. /
AVAILABLE WITH SPRING FOR
AUTOMATIC CLOSURE WITH
ADJUSTABLE FORCE, OR
FREE HINGE. /
DISPONIBLE CON MUELLE
PARA EL CIERRE AUTOMÁTICO
CON FUERZA AJUSTABLE, O
BISAGRA LIBRE.



HPL HIGH PRESSURE LAMINATES /
TERMOLAMINADO DE ALTA PRESSÃO
FENÓLICO /

Power
adjustable
spring

NEW

SM.005.C

Dobradiça de sobrepor com mola para auto-fecho (reversível). Mola com força ajustável / Flat hinge to overlap with spring for self closing (reversible). Spring with power adjustment / Bisagra plana de sobreponer con muelle para autocierre (reversible). Muelle con ajuste de fuerza.

Material: EN 1.4301/AISI 304
Acabamento / Finish / Acabado: satinado / satin
Opcional / Optional: pvd titanium black (.TB); gold (.TG)



SM.005.C
EN 1.4301 / AISI 304
Satinado / Satin / Satin



SM.005.C.TB
EN 1.4301 + PVD TITANIUM BLACK
Satinado / Satin / Satin



SM.005.C.TG
EN 1.4301 + PVD TITANIUM GOLD
Satinado / Satin / Satin

**SM.042.A**

Parafuso de ligação para acessórios de fenólico (HPL) / Screw connection for phenolic accessories (HPL) / Tornillo pasante de conexión para accesorios de fenolico HPL.

.TB .TG

SM.005.B

Dobradiça de sobrepor (reversível) / Flat hinge to overlap (reversible) / Bisagra plana de sobreponer (reversible).

Material: EN 1.4301/AISI 304
Acabamento / Finish / Acabado: satinado / satin
Opcional / Optional: pvd titanium black (.TB); gold (.TG)



SM.005.B
EN 1.4301 / AISI 304
Satinado / Satin / Satin



SM.005.B.TB
EN 1.4301 + PVD TITANIUM BLACK
Satinado / Satin / Satin



SM.005.B.TG
EN 1.4301 + PVD TITANIUM GOLD
Satinado / Satin / Satin

**SM.042.A**

Parafuso de ligação para acessórios de fenólico (HPL) / Screw connection for phenolic accessories (HPL) / Tornillo pasante de conexión para accesorios de fenolico HPL.

.TB .TG

FECHO COM INDICADOR DE COR "EASY FIX" / BATHROOM LATCH WITH INDICATOR "EASY FIX" / CIERRE DE BAÑO CON INDICADOR "EASY FIX".

JUST CLICK LATCH

FECHO COM SISTEMA DE
MONTAGEM RÁPIDA "EASY FIX" /
LATCH WITH QUICK ASSEMBLING
SYSTEM "EASYFIX" /
CIERRE CON SISTEMA DE MONTAJE
RÁPIDO "EASY FIX".

FECHO INTERIOR COM MANÍPULO
QUE SERVE SIMULTANEAMENTE
DE PUXADOR. /
INTERNAL LATCH WITH HANDLE
THAT SIMULTANEOUSLY SERVES AS
KNOB. /
CIERRE INTERIOR CON ASA QUE
SIRVE AL MISMO TIEMPO DE
TIRADOR.



EASY FIX

INSTALLATION IN
7 SECONDS

HPL HIGH PRESSURE LAMINATES /
TERMOLAMINADO DE ALTA PRESSÃO
FENÓLICO /

SM.031 EASY FIX
Fecho com indicador "livre-
ocupado" / Bathroom latch with
indicator / Cierre de baño con
indicador.

Material: EN 1.4301/AISI 304
Acabamento / Finish / Acabado:
satinado / satin
Opcional / Optional:
pvd titanium black (.TB); gold (.TG) /
copper (.TCO); / natural (.TN)

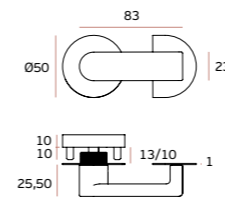

1. SM.031.TB
3. SM.031.TCO

2. SM.031.TG
4. SM.031.TN

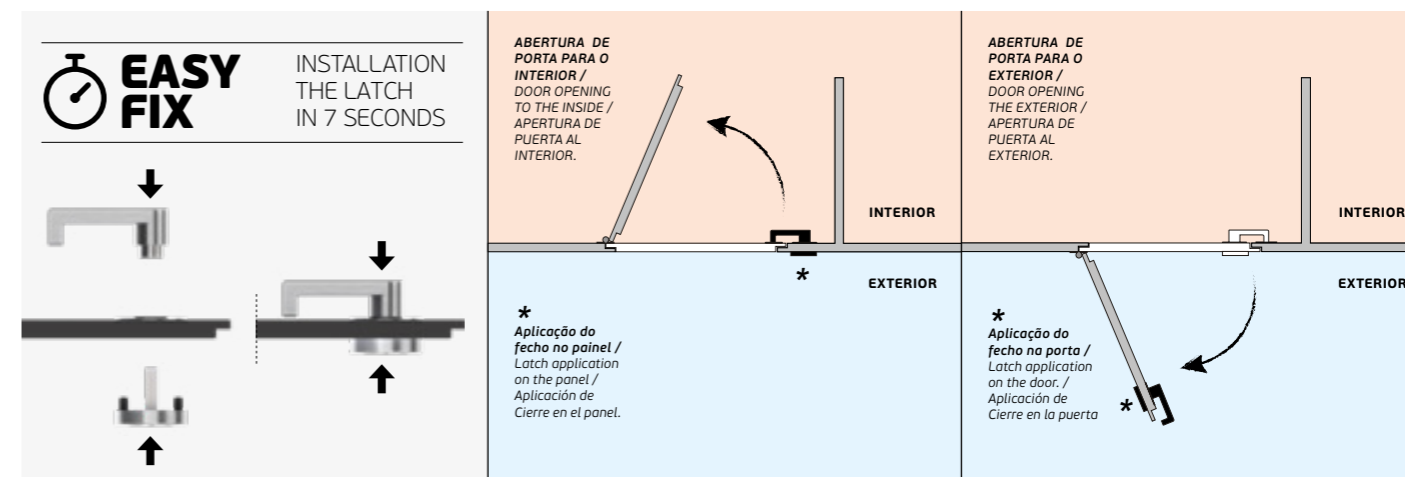

1- Botão de fecho com sistema de montagem rápida /

Locking button with quick assembling system /
Botón de bloqueo con sistema de montaje rápido.

2 - Anilha anti-fricção /

Anti friction washer / Arandella anti fricción.

3 - Espelho em aço inox /

Stainless steel cover / Roseta en acero inox.

4 - Indicador livre/ocupado (pode ser optado na instalação) /

Indicator for snib indicator (can be chosen on installation) /
Indicador de cierre baño (opcional en la instalación).

5 - Chave para desbloqueio /

Unlocking key / Llave de desbloqueo

6 - Fecho exterior / Outside Lock / Cierre exterior.

7 - Chapa testa em aço inox EN 1.4301 /

Strike plate made in stainless steel EN 1.4301 /
Cerradero en acero inox EN 1.4301

8 - Chave para remoção do botão /

Key to remove the button / Llave para quitar el botón.

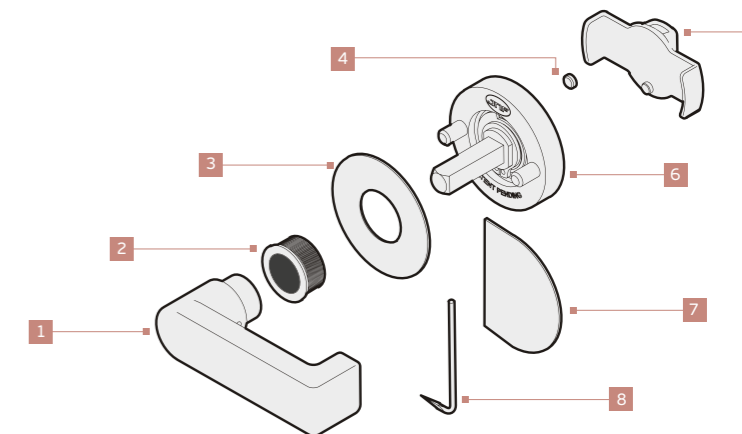

FECHO / PUXADOR PARA CABINES HPL / LATCH / KNOB FOR HPL CABINET / CIERRE / POMO PARA CABINAS HPL.

HPL HIGH PRESSURE LAMINATES /
TERMOLAMINADO DE ALTA PRESSÃO
FENÓLICO /

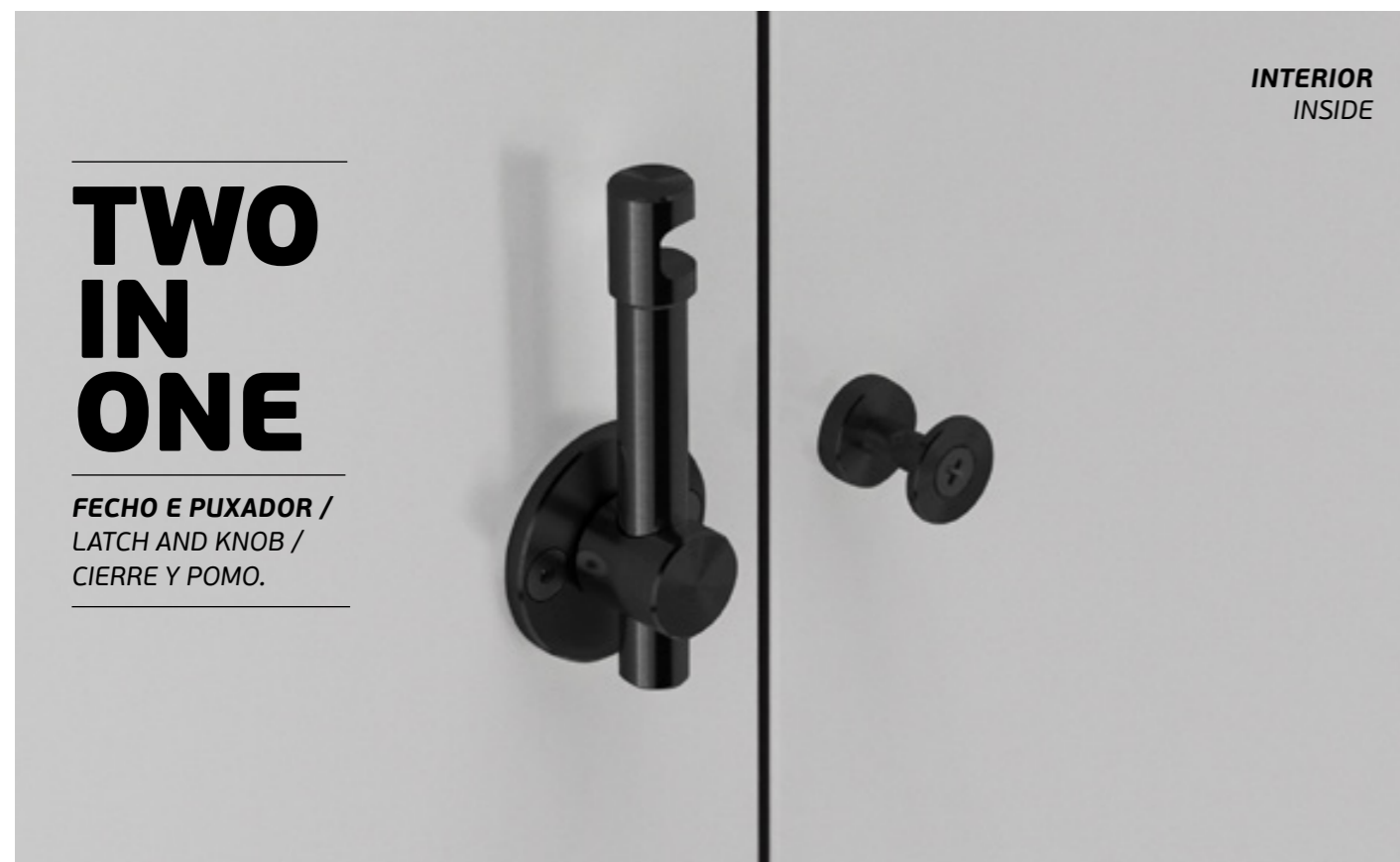

SM.060

Fecho com indicador "livre-ocupado"/
Bathroom latch with indicador / Cierre de
baño con indicador.

Material: EN 1.4301/AISI 304
Acabamento / Finish / Acabado:
satinado / satin
Opcional / Optional:
pvd titanium black (.TB); gold (.TG) /
copper (.TCO); / natural (.TN)

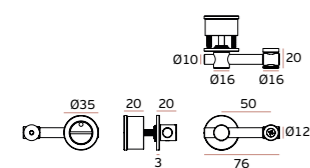

1. SM.060.TB
3. SM.060.TCO

2. SM.060.TG
4. SM.060.TN

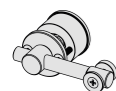
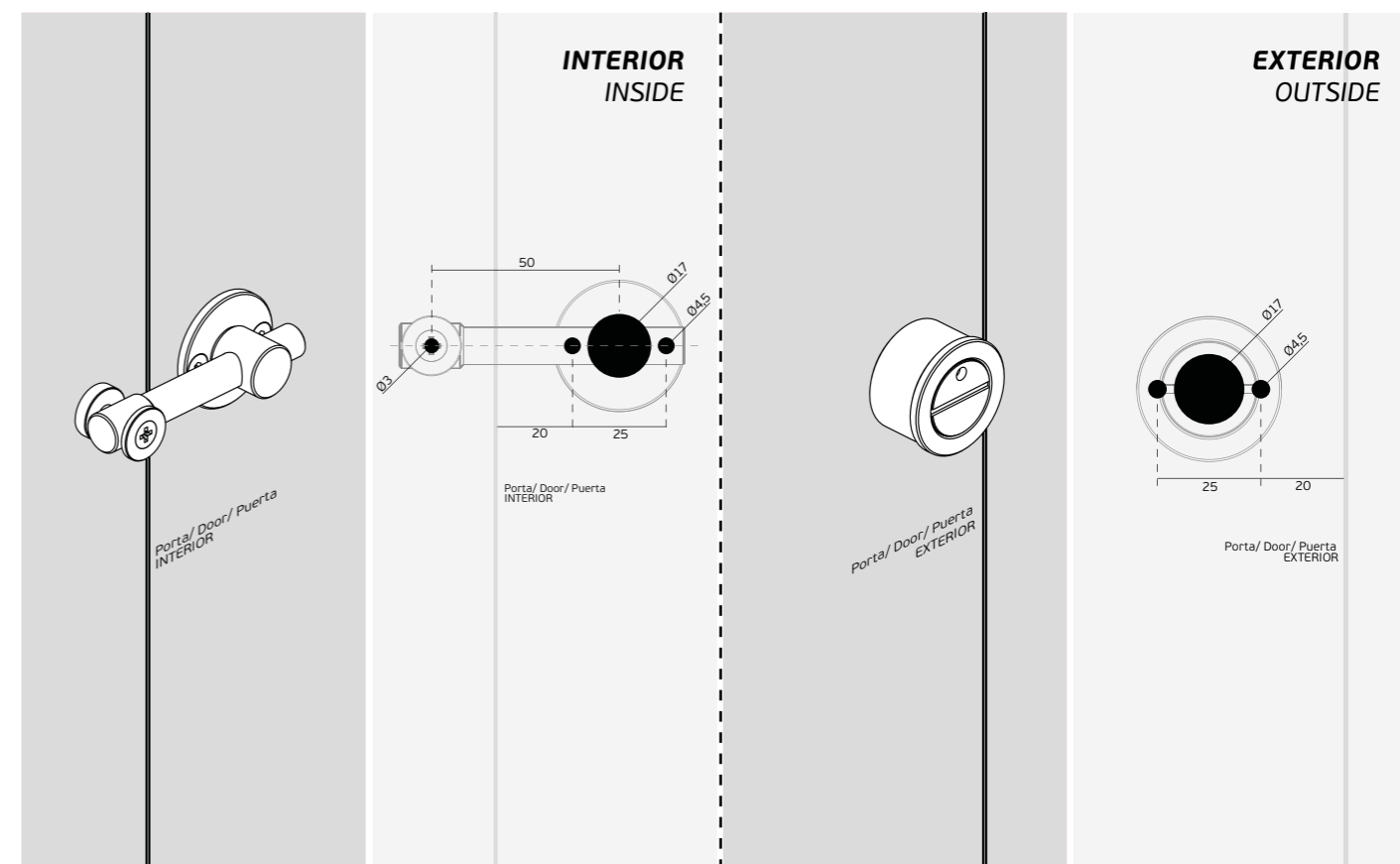

FECHO PARA CABINES HPL / LATCH FOR HPL CABINET / CIERRE PARA CABINAS HPL.



SIMPLE

**FECHO PARA CABINES EM HPL
MAQUINAÇÃO APENAS NA PORTA
OU NO PAINEL FIXO /
LATCH FOR HPL CABINETS
MACHINING ONLY ON THE DOOR
OR ON THE FIXED PANEL /
CIERRE PARA CABINAS EN HPL
MECANIZADO SOLO EN LA PUERTA
O EN EL PANEL FIJO.**

**2 OPÇÕES DE DESBLOQUEIO DE
EMERGENCIA PELO EXTERIOR.
COM FENDA PARA MOEDA OU POR
CHAVE TRIANGULAR /
2 OPTIONS FOR EMERGENCY
UNLOCK. COIN SLOT OR
TRIANGULAR KEY /
2 OPCIONES DE DESBLOQUEO
DE EMERGENCIA POR EXTERIOR.
RANURA PARA MONEDAS O LLAVE
TRIANGULAR.**



HPL HIGH PRESSURE LAMINATES /
TERMOLAMINADO DE ALTA PRESSÃO
FENÓLICO /

SM.030

**Fecho para wc com indicador
"livre-ocupado" /
Bathroom latch with indicator /
Cierre de baño con indicador.**

Material: EN 1.4301/AISI 304
Acabamento / Finish / Acabado:
satinado / satin

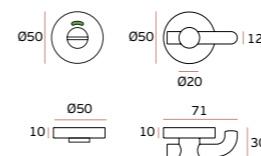

**RANHURA PARA
MOEDA PARA
ABERTURA PELO
EXTERIOR /
COIN SLOT FOR
EMERGENCY OPEN
FROM THE OUTSIDE /
FENDA PARA MONEDA
PARA ABERTURA DE
EMERGENCIA POR EL
EXTERIOR.**

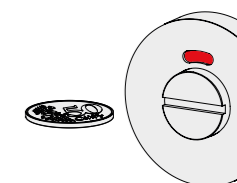

SM.029

**Fecho para wc com indicador
"livre-ocupado" /
Bathroom latch with indicator /
Cierre de baño con indicador.**

Material: EN 1.4301/AISI 304
Acabamento / Finish / Acabado:
satinado / satin

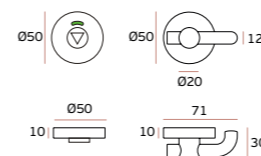

**ABERTURA DE
EMERGENCIA PELO
EXTERIOR COM CHAVE
TRIANGULAR /
EMERGENCY OPENING
FROM THE OUTSIDE WITH
TRIANGULAR KEY /
APERTURA DE
EMERGENCIA POR EL
EXTERIOR CON LLAVE
TRIANGULAR.**

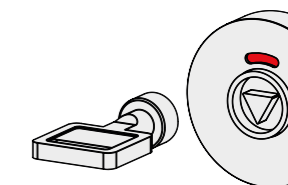

IN.04.251

**Chave triangular /
Triangular key /
Llave triangular.**

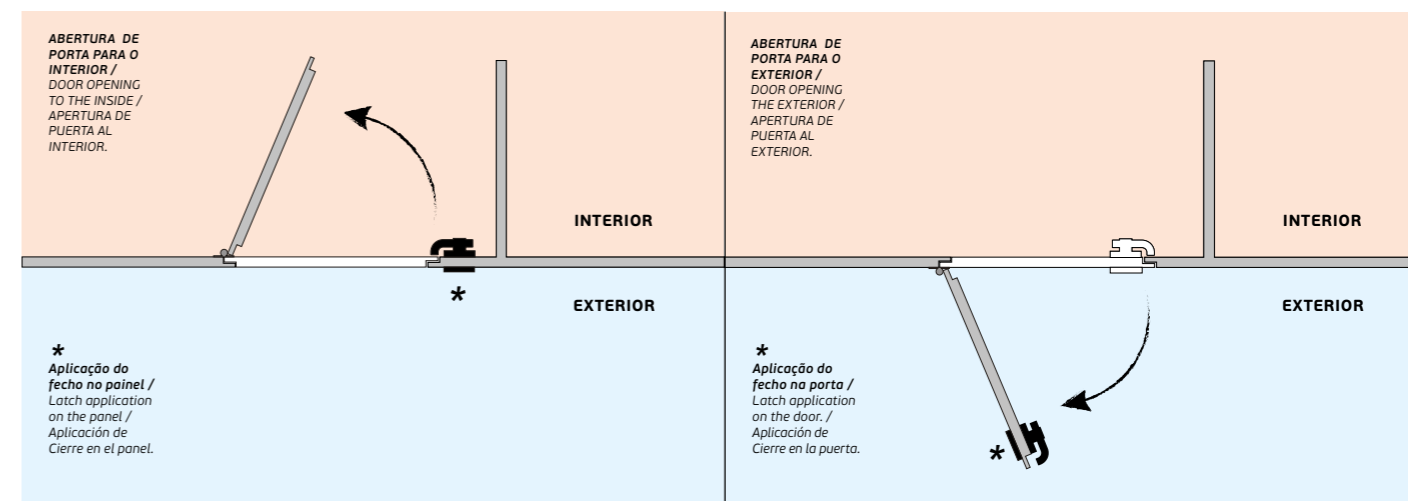

FECHO / PUXADOR PARA CABINES HPL / LATCH / KNOB FOR HPL CABINET / CIERRE / POMO PARA CABINAS HPL.

SLIDE TO LOCK / UNLOCK

ÇO INOX / STAINLESS STEEL /
ACERO INOX EN 1.4301 - AISI 304

ACABAMENTOS EM PVD TITÂNIO /
TITANIUM PVD FINISH /
ACABADOS DE PVD TITANIO



HPL HIGH PRESSURE LAMINATES /
TERMOLAMINADO DE ALTA PRESSÃO
FENÓLICO /

SM.035 SLIDE

Fecho /
Bolt / Pasador

Material: EN 1.4301/AISI 304
Acabamento / Finish / Acabado:
satinado / satin
Opcional / Optional:
pvd titanium black (.TB); gold (.TG) /
copper (.TCO); / natural (.TN)

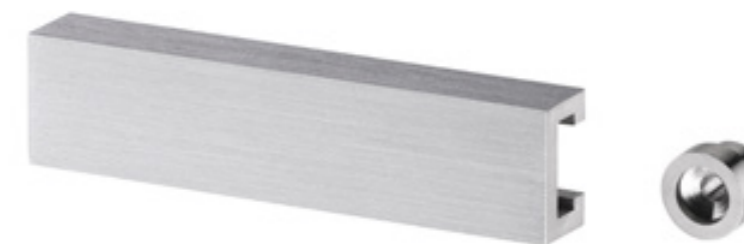
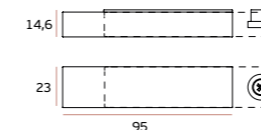

1. SM.035.TB

2. SM.035.TG

3. SM.035.TCO

4. SM.035.TN

SM.035.P SLIDE

Fecho /
Bolt / Pasador

Material: EN 1.4301/AISI 304
Acabamento / Finish / Acabado:
polido / polished / pulido (.P)

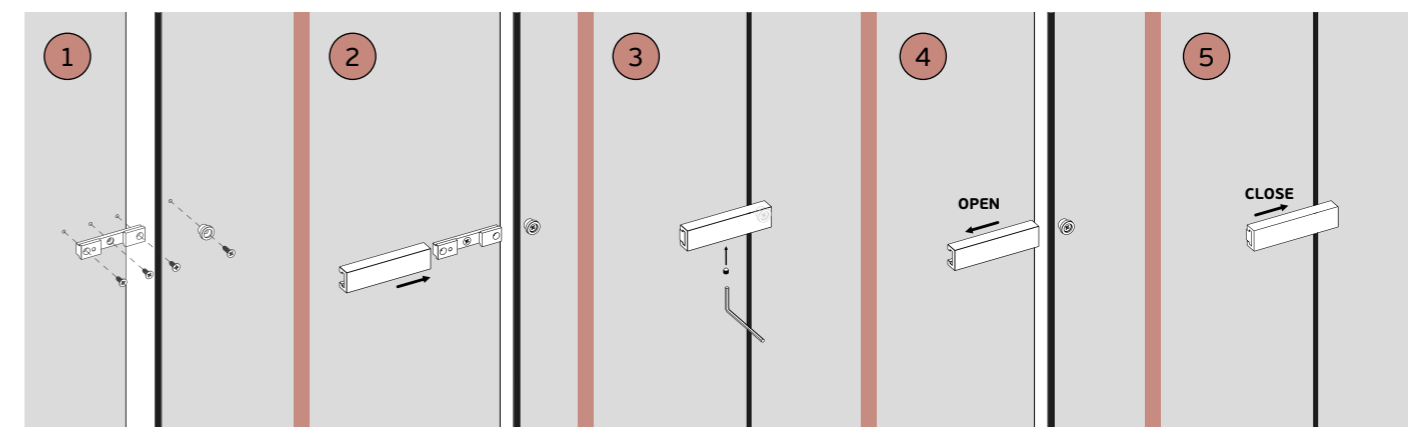
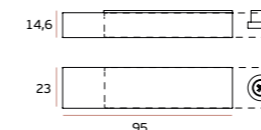

FECHO PARA CABINES HPL / LATCH FOR HPL CABINET / CIERRE PARA CABINAS HPL.

SLIDING DOOR LOCK FOR HPL

**FECHADURA DE
SOBREPOR PARA PORTA
DE CORRER EM HPL /
RIM LOCK FOR SLIDING
DOOR IN HPL /
CERRADURA DE
SOBREPONER PARA
PUERTA CORREDERA
EN HPL**

**APLICÁVEL COM FECHOS
WC COM DESBLOQUEIO
DE EMERGÊNCIA. /
APPLICABLE WITH WC
SNIB INDICATOR WITH
EMERGENCY RELEASE. /
APLICABLE CON
CONDENA DE BAÑO
CON DESBLOQUEO DE
EMERGENCIA.**



HPL HIGH PRESSURE LAMINATES /
TERMOLAMINADO DE ALTA PRESSÃO
FENÓLICO /

SM.036

**Fechadura para portas de correr,
para aplicar com fecho livre-
ocupado. Testa para parede
incluída / Lock for sliding door to
use with snib indicator. Strike plate
included / Cerradura para puertas
correderas para aplicar con condena
de baño. Cerradero incluido.**

Material: EN 1.4301 / AISI 304
Acabamento / Finish / Acabado:
satinado / satin

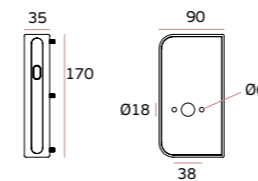

SM.038

**Testa para aplicar com SM.036 e
SM.037 (não incluída) / Strike plate
to use with SM.036 and SM.037 (not
included) / Cerradero para aplicar con
SM.036 y SM.03 (no incluido).**

Material: EN 1.4301 / AISI 304
Acabamento / Finish / Acabado:
satinado / satin

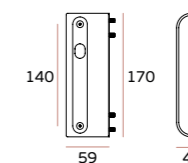

IN.04.110

**Fecho wc com ranhura para moeda com ou sem indicador (pode ser
optado na instalação) / Bathroom snib indicator with coin slot with or
without color indication (can be chosen on instalation) / Condeña de baño
con fenda para moneda con o sin indicador (opcional en la instalación).**



IN.04.266

**Fecho wc com ranhura para moeda com ou sem indicador (pode ser
optado na instalação) / Bathroom snib indicator with coin slot with or
without color indication (can be chosen on instalation) / Condeña de baño
con fenda para moneda con o sin indicador (opcional en la instalación).**



IN.04.112

**Fecho wc com ranhura para moeda com ou sem indicador (pode ser
optado na instalação) / Bathroom snib indicator with coin slot with or
without color indication (can be chosen on instalation) / Condeña de baño
con fenda para moneda con o sin indicador (opcional en la instalación).**



IN.04.109

**Fecho wc com ranhura para moeda com ou sem indicador (pode ser
optado na instalação) / Bathroom snib indicator with coin slot with or
without color indication (can be chosen on instalation) / Condeña de baño
con fenda para moneda con o sin indicador (opcional en la instalación).**



FECHO PARA CABINES HPL /
LATCH FOR HPL CABINET /
CIERRE PARA CABINAS HPL.

SLIDING DOOR LOCK FOR HPL

**FECHADURA DE
SOBREPOR PARA PORTA
DE CORRER EM HPL /**
RIM LOCK FOR SLIDING
DOOR IN HPL /
CERRADURA DE
SOBREPONER PARA
PUERTA CORREDERA
EN HPL

**APLICÁVEL COM
CILINDRO DE PERFIL
EUROPEU. /**
APPLICABLE WITH
EUROPEAN CYLINDER/
APLICABLE CON
CINLINDRO EUROPEO.



HPL HIGH PRESSURE LAMINATES /
TERMOLAMINADO DE ALTA PRESSÃO
FENÓLICO /

SM.037

**Fechadura para portas de correr,
para aplicar com cilindro. Testa
para parede incluída /** Lock for
sliding door to use with european
cylinder. Strike plate included.
Cerradura para puertas correderas
para aplicar con cilindro. Cerradero
incluso.

Material: EN 1.4301 / AISI 304
Acabamento / Finish / Acabado:
satinado / satin

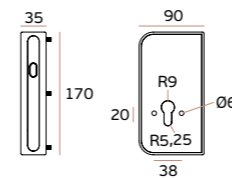

SM.038

**Testa para aplicar com SM.036 e
SM.037 (não incluída) /** Strike plate
to use with SM.036 and SM.037 (not
included) / Cerradero para aplicar con
SM.036 y SM.03 (no incluido).

Material: EN 1.4301 / AISI 304
Acabamento / Finish / Acabado:
satinado / satin

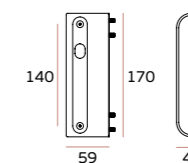

IN.19.S11.F.30.40.SB IN.19.S11.F.40.30.SB

Cilindro europeu modular fenda-botão
Modular european cylinder coin slot - button /
Cilindro modular europeu fenda - pomo.



IN.19.S11.30.40.SB IN.19.S11.40.30.SB

Cilindro europeu modular chave-botão
Modular european cylinder key - button /
Cilindro modular europeu llave - pomo



BOTÕES DIPONIVEIS

AVAILABLE KNOBS / POMOS DISPONIBLES



IN.04.28R.Y08N

**Entrada de chave para cilindro
com interior em nylon /**
European cylinder key hole with nylon base /
Bocallave para bombillo con base en nylon.



PUXADOR PARA CABINES HPL / KNOB FOR HPL CABINET / POMO PARA CABINAS HPL.

DOUBLE KNOB FOR HPL

PUXADOR DUPLO PARA
PAINÉIS DE HPL COM
SISTEMA DE FIXAÇÃO
ANTIVANDALISMO /
DOUBLE KNOB FOR HPL
PANELS WITH
ANTI-VANDALISM
FIXING SYSTEM /
TIRADOR DOBLE PARA
PANELES DE HPL CON
SISTEMA DE FIJACIÓN
ANTIVANDÁLICO.

HPL HIGH PRESSURE LAMINATES /
TERMOLAMINADO DE ALTA PRESSÃO
FENÓLICO /

IN.75.051.D

Puxador de porta duplo anti-vandalismo / Double door knob with antivandalism fixing / Tirador de puerta doble anti-vandalismo.

Material: EN 1.4301/AISI 304
Acabamento / Finish / Acabado:
satinado / satin
Opcional / Optional:
pvd titanium black (.TB); gold (.TG) /
copper (.TCO); / natural (.TN)

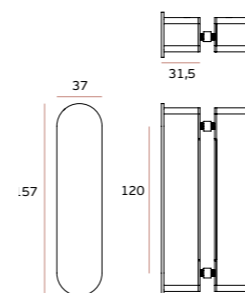

1. IN.75.051.D.TB
3. IN.75.051.D.TCO

2. IN.75.051.D.TG
4. IN.75.051.D.TN



IN.75.050.D

Puxador de porta duplo anti-vandalismo / Double door knob with antivandalism fixing / Tirador de puerta doble anti-vandalismo.

Material: EN 1.4301/AISI 304
Acabamento / Finish / Acabado:
satinado / satin
Opcional / Optional:
pvd titanium black (.TB); gold (.TG) /
copper (.TCO); / natural (.TN)

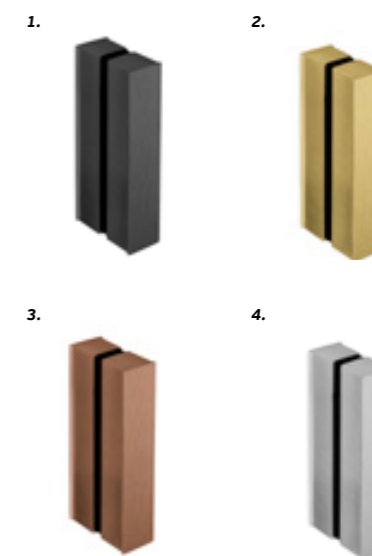
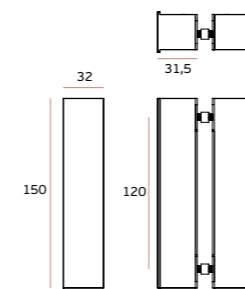

1. IN.75.050.D.TB
3. IN.75.050.D.TCO

2. IN.75.050.D.TG
4. IN.75.050.D.TN



PUXADOR PARA CABINES HPL / KNOB FOR HPL CABINET / POMO PARA CABINAS HPL.

IN.75.040

Puxador de porta duplo anti-vandalismo / Double door knob with antivandalism fixing / Tirador de puerta doble anti-vandalismo.

Material: EN 1.4301/AISI 304
Acabamento / Finish / Acabado: satinado / satin
Opcional / Optional: pvd titanium black (.TB); gold (.TG) / copper (.TCO); / natural (.TN)

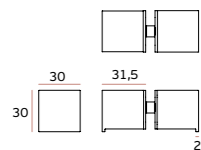

1.



2.



3.



4.



1. IN.75.040.TB
 3. IN.75.040.TCO

2. IN.75.040.TG
 4. IN.75.040.TN

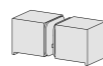

IN.75.041

Puxador de porta duplo anti-vandalismo / Double door knob with antivandalism fixing / Tirador de puerta doble anti-vandalismo.

Material: EN 1.4301/AISI 304
Acabamento / Finish / Acabado: satinado / satin
Opcional / Optional: pvd titanium black (.TB); gold (.TG) / copper (.TCO); / natural (.TN)

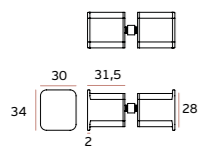

1.



2.



3.



4.



1. IN.75.041.TB
 3. IN.75.041.TCO

2. IN.75.041.TG
 4. IN.75.041.TN

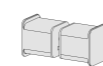

IN.75.042

Puxador de porta duplo anti-vandalismo / Double door knob with antivandalism fixing / Tirador de puerta doble anti-vandalismo.

Material: EN 1.4301/AISI 304
Acabamento / Finish / Acabado: satinado / satin
Opcional / Optional: pvd titanium black (.TB); gold (.TG) / copper (.TCO); / natural (.TN)

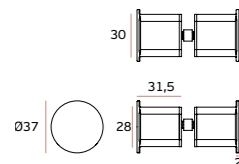

1.



2.



3.



4.



1. IN.75.042.TB
 3. IN.75.042.TCO

2. IN.75.042.TG
 4. IN.75.042.TN

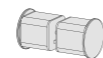

CABIDES PARA CABINES HPL / HOOKS FOR HPL CABINET / PERCHAS PARA CABINAS HPL.



HOOKS FOR HPL

CABIDES DESENVOLVIDOS PARA FÁCIL E RÁPIDA APLICAÇÃO EM HPL, GARANTINDO A RESISTÊNCIA NECESSÁRIA PARA OS ESPAÇOS ONDE SÃO APLICADOS. / HOOKS DEVELOPED FOR EASY AND QUICK APPLICATION IN HPL, GUARANTEEING THE NECESSARY RESISTANCE TO THE SPACES WHERE THEY ARE APPLIED. / COLGADORES DESARROLLADOS PARA UNA APLICACIÓN FÁCIL Y RÁPIDA EN HPL, GARANTIZANDO LA RESISTENCIA NECESARIA A LOS ESPACIOS DONDE SE APLICAN.

CABIDES PARA CABINES HPL / HOOKS FOR HPL CABINET / PERCHAS PARA CABINAS HPL.

IN.14.020

Cabide / Hook / Percha.
Design: Pedro Queirós

Material: EN 1.4372

Acabamento / Finish / Acabado:
satinado / satin

Opcional / Optional:
pvd titanium black (.TB); gold (.TG) /
copper (.TCO); / natural (.TN)

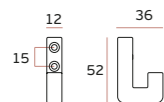

1. IN.14.020.TB
3. IN.14.020.TCO

2. IN.14.020.TG
4. IN.14.020.TN

IN.14.010

Cabide / Hook / Percha.
Design: Pedro Queirós

Material: EN 1.4372

Acabamento / Finish / Acabado:
satinado / satin

Opcional / Optional:
pvd titanium black (.TB); gold (.TG) /
copper (.TCO); / natural (.TN)

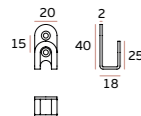

1. IN.14.010.TB
3. IN.14.010.TCO

2. IN.14.010.TG
4. IN.14.010.TN

IN.14.546

Cabide / Hook / Percha.

Material: EN 1.4401 / AISI 316

Acabamento / Finish / Acabado:
satinado / satin

Opcional / Optional:
pvd titanium black (.TB); gold (.TG) /
copper (.TCO); / natural (.TN)

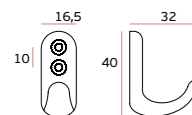

1. IN.14.546.TB
3. IN.14.546.TCO

2. IN.14.546.TG
4. IN.14.546.TN

TWO IN ONE

**CABIDE E
BATENTE DE PORTA /
HOOK E DOOR
STOPPER /
PERCHA E
TOPE DE PUERTA**



SM.008

**Cabide / Batente de porta anti-
vandalismo / Hook / Door stopper
concealed fixing / Percha / Tope te
puerta anti-vandalismo.**

Material: EN 1.4301 / AISI 304
Acabamento / Finish / Acabado:
satinado / satin

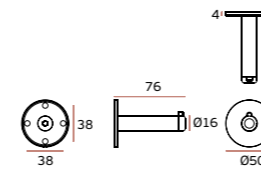

IN.14.541

Cabide / Hook / Percha.

Material: EN 1.4301 / AISI 304
Acabamento / Finish / Acabado:
satinado / satin

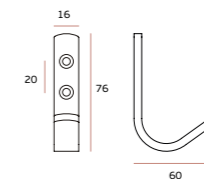

IN.14.546.F

Cabide / Hook / Percha.

Material: EN 1.4401 / AISI 316
Acabamento / Finish / Acabado:
raw

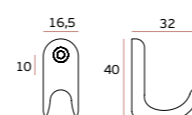

SM.042.A

**Parafuso de ligação para
acessórios de fenólico (HPL) /
Screw connection for phenolic
accessories (HPL) /
Tornillo pasante de conexión para
accesorios de fenolico HPL).**



SISTEMA MODULAR AÉREO PARA TUBO Ø19mm / OVERHEAD MODULAR SYSTEM FOR Ø19mm TUBE / SISTEMA MODULAR AÉREO PARA TUBO Ø19MM /

Ø19mm AERIAL SYSTEM

SOLUÇÃO COM FERRAGENS DE SECÇÃO REDONDA COM Ø19MM. GARANTINDO A ESTABILIDADE NECESSÁRIA, MAS COM MENOS IMPACTO QUE AS FERRAGENS TRADICIONAIS. /

SOLUTION WITH Ø19MM ROUND SECTION FITTINGS. GUARANTEEING THE NECESSARY STABILITY, BUT WITH LESS IMPACT THAN TRADITIONAL HARDWARE. /

SOLUCIÓN CON ACCESORIOS DE SECCIÓN REDONDA DE Ø19MM. GARANTIZANDO LA ESTABILIDAD NECESARIA, PERO CON MENOS IMPACTO QUE LOS HERRAJES TRADICIONALES.

SM.002.19

Suporte superior para painel /
 Upper panel holder / Soporte superior para panel.

Material: EN 1.4301 / AISI 304
Acabamento / Finish / Acabado:
 satinado / satin

Opcional / Optional:
 pvd titanium black (.TB); gold (.TG) /
 copper (.TCO); / natural (.TN)

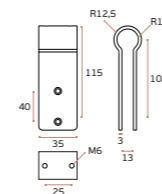

1.



2.



3.



4.



SM.040

Parafuso de ligação para acessórios de fenólico / Screw connection for phenolic accessories / Tornillo pasante de conexión para accesorios de fenolico.



SM.041

Parafuso de ligação para acessórios de fenólico / Screw connection for phenolic accessories / Tornillo pasante de conexión para accesorios de fenolico.

1. SM.002.19.TB
 3. SM.002.19.TCO

2. SM.002.19.TG
 4. SM.002.19.TN



SM.022

Suporte superior para painel /
 Upper panel holder / Soporte superior para panel.

Material: EN 1.4301 / AISI 304
Acabamento / Finish / Acabado:
 satinado / satin

Opcional / Optional:
 pvd titanium black (.TB); gold (.TG) /
 copper (.TCO); / natural (.TN)

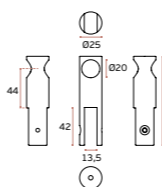

1.



2.



3.



4.



1. SM.022.TB
 3. SM.022.TCO

2. SM.022.TG
 4. SM.022.TN

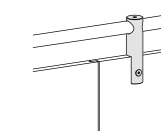

SISTEMA MODULAR AÉREO PARA TUBO Ø19mm / OVERHEAD MODULAR SYSTEM FOR Ø19mm TUBE / SISTEMA MODULAR AÉREO PARA TUBO Ø19MM /

SM.010.A.19.3000

Tubo Ø19 com 3000mm /
 Tube Ø19 with 3000mm /
 Tubo Ø19 con 3000mm.

Material: EN 1.4301 / AISI 304
Acabamento / Finish / Acabado:
 satinado / satin

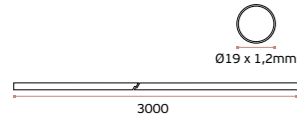

SM.010.A.19.2000

Tubo Ø19 com 2000mm /
 Tube Ø19 with 2000mm /
 Tubo Ø19 con 2000mm.

Material: EN 1.4301 / AISI 304
Acabamento / Finish / Acabado:
 satinado / satin
Opcional / Optional:
 pvd titanium black (.TB); gold (.TG) /
 copper (.TCO); / natural (.TN)

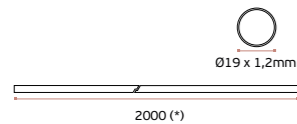

1. SM.010.A.19.2000.TB 2. SM.010.A.19.2000.TG 3. SM.010.A.19.2000.TCO

SM.010.A.19.1000.TN

Tubo Ø19 com 1000mm /
 Tube Ø19 with 1000mm /
 Tubo Ø19 con 1000mm.

Material: EN 1.4301 / AISI 304
Acabamento / Finish / Acabado:
 satinado / satin
Opcional / Optional:
 pvd titanium natural (.TN)

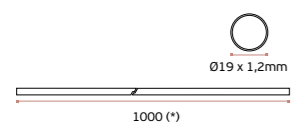

SM.010.C.19

Conector para tubo Ø19mm /
 Tube connector Ø19mm /
 Conector de tubo Ø19mm.

Material: alumínio / aluminium
Acabamento / Finish / Acabado:
 satinado / satin

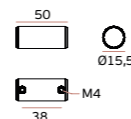

SM.011.19

Suporte de tubo com fixação à
 parede / Wall mounting tube
 support / Soporte de tubo con
 sujeción a pared.

Material: EN 1.4301 / AISI 304
Acabamento / Finish / Acabado:
 satinado / satin
Opcional / Optional:
 pvd titanium black (.TB); gold (.TG) /
 copper (.TCO); / natural (.TN)

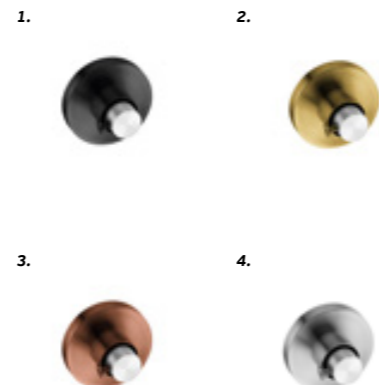

1. SM.011.19.TB 2. SM.011.19.TG
 3. SM.011.19.TCO 4. SM.011.19.TN

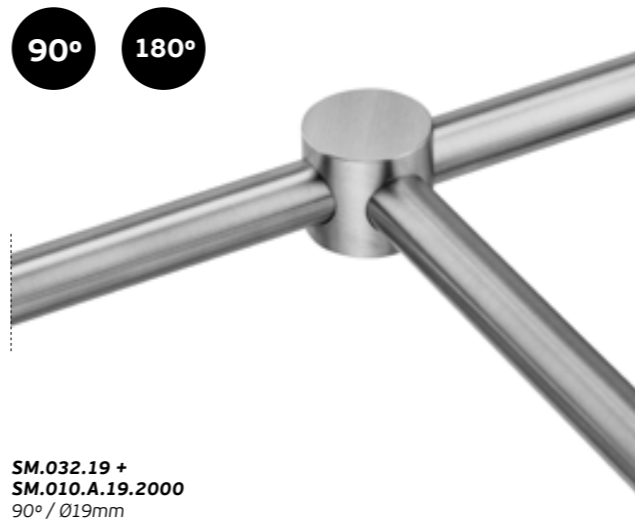

SM.032.19 +
 SM.010.A.19.2000
 90° / Ø19mm

SM.033.19

União de tubo a 90° e 180° para
 tubo de Ø19mm / Tube connector
 at 90° and 180° for Ø19mm / Union
 de tubo a 90° y 180° para tubo de
 Ø19mm.

Material: EN 1.4301 / AISI 304
Acabamento / Finish / Acabado:
 satinado / satin
Opcional / Optional:
 pvd titanium black (.TB); gold (.TG) /
 copper (.TCO); / natural (.TN)

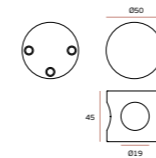

1. SM.033.19.TB 2. SM.033.19.TG
 3. SM.033.19.TCO 4. SM.033.19.TN



SM.033.19 +
 SM.010.A.19.2000
 90° + 180° / Ø19mm

SM.032.19

União de tubo a 90° para tubo
 Ø19mm / Tube connector at 90° for
 Ø19mm tube / Union de tubo a 90°
 para tubo de Ø19mm.

Material: EN 1.4301 / AISI 304
Acabamento / Finish / Acabado:
 satinado / satin
Opcional / Optional:
 pvd titanium black (.TB); gold (.TG) /
 copper (.TCO); / natural (.TN)

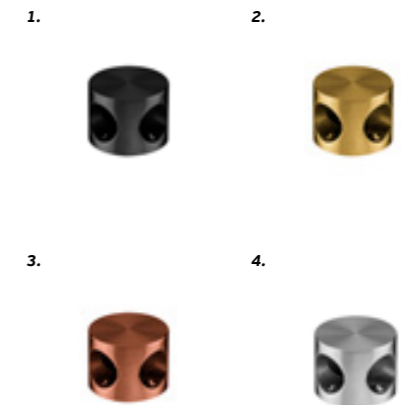
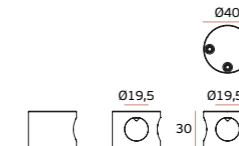

1. SM.032.19.TB 2. SM.032.19.TG
 3. SM.032.19.TCO 4. SM.032.19.TN



SISTEMA MODULAR PARA TUBO 20X20mm / OVERHEAD MODULAR SYSTEM FOR 20X20mm TUBE / SISTEMA MODULAR AÉREO PARA TUBO 20X20mm /

20X20mm AERIAL SYSTEM

SOLUÇÃO COM FERRAGENS TUBULARES DE SECÇÃO QUADRADA DE 20X20MM, ELEMENTO INOVADOR NAS CABINES FENÓLICAS. ESTE SISTEMA PERMITE QUE AS FERRAGENS DE FIXAÇÃO AÉREAS DOS PAINÉIS FIQUE OCULTO PELO EXTERIOR, CRIANDO UMA SOLUÇÃO MAIS "CLEAN" QUE O TRADICIONAL. /

SOLUTION WITH TUBULAR FITTINGS WITH A SQUARE SECTION OF 20X20MM, AN INNOVATIVE ELEMENT IN THE PHENOLIC CABINS. THIS SYSTEM ALLOWS THE OVERHEAD PANEL HARDWARE TO BE HIDDEN FROM THE OUTSIDE, CREATING A MORE "CLEAN" SOLUTION THAN THE TRADITIONAL ONE. /

SOLUCIÓN CON HERRAJES TUBULARES DE SECCIÓN CUADRADA DE 20X20MM, UN ELEMENTO INNOVADOR EN LAS CABINAS FENÓLICAS. ESTE SISTEMA PERMITE OCULTAR LOS HERRAJES DE LOS PANELES SUPERIORES DESDE EL EXTERIOR, CREANDO UNA SOLUCIÓN MÁS "CLEAN" QUE LA TRADICIONAL.

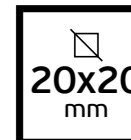

SM.010.Q.20.3000

Tubo quadrado
20x20mm (3000mm) /
 Square tube 20x20mm
 (3000mm) / Tubo cuadrado
 20x20mm (3000mm)

Material: EN 1.4301 / AISI 304

Acabamento / Finish /

Acabado: satinado / satin

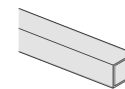
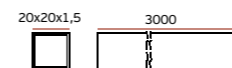

SM.010.Q.20.1000.

Tubo quadrado
20x20mm (1000mm) /
 Square tube 20x20mm
 (1000mm) / Tubo cuadrado
 20x20mm (1000mm)

Material: EN 1.4301 / AISI 304

Acabamento / Finish /

Acabado: satinado / satin

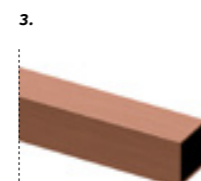
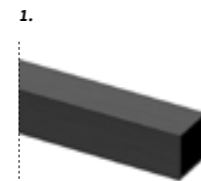
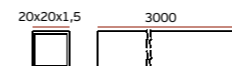

1. SM.010.Q.20.1000.TB

3. SM.010.Q.20.1000.TCO

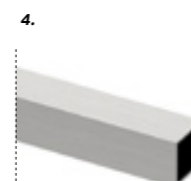
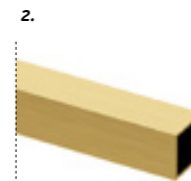

2. SM.010.Q.20.1000.TG

4. SM.010.Q.20.1000.TN

SM.010.QC
Conector para tubo 20x20mm /
 Tube connector 20x20mm /
 Conector de tubo 20x20mm.

Material: alumínio / aluminium

Acabamento / Finish / Acabado:

satinado / satin

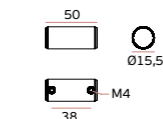

SM.010.QC.2

Gabari para furação de tubo 20x20mm /
 Drilling template For tube 20x20mm /
 Plantilla de perforación para tubo 20x20mm.

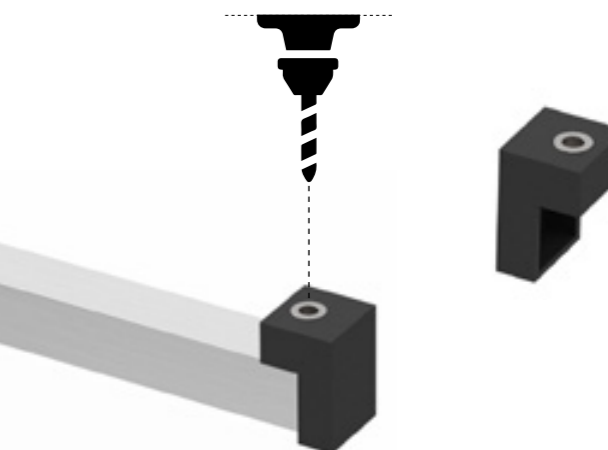

SISTEMA MODULAR PARA TUBO 20X20mm /
OVERHEAD MODULAR SYSTEM FOR 20X20mm TUBE /
SISTEMA MODULAR AÉREO PARA TUBO 20X20mm /

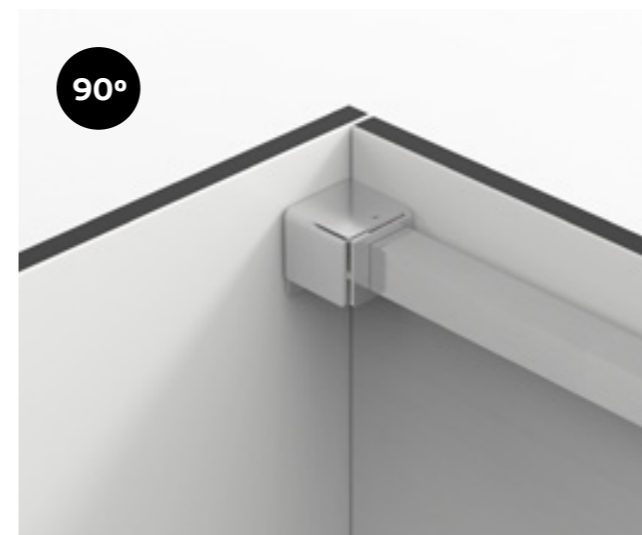
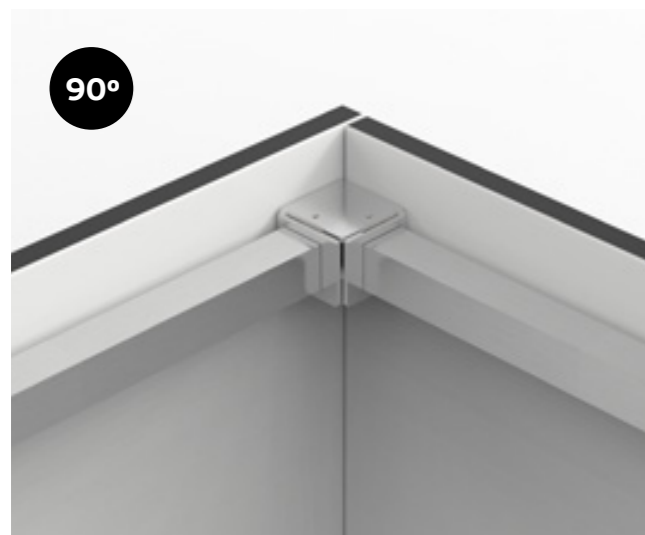
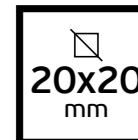

SM.062
Suporte superior para painel 90° /
Upper panel holder 90° /
Soporte superior para panel 90°.

Material: EN 1.4301 / AISI 304
Acabamento / Finish / Acabado:
satinado / satin
Opcional / Optional:
pvd titanium black (.TB); gold (.TG) /
copper (.TCO); / natural (.TN)

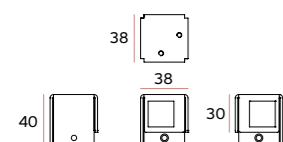

SM.042.B SM.042.F



1. SM.062.TB 2. SM.062.TG
3. SM.062.TCO 4. SM.062.TN

SM.063
Suporte superior para painel /
Upper panel holder /
Soporte superior para panel.

Material: EN 1.4301 / AISI 304
Acabamento / Finish / Acabado:
satinado / satin
Opcional / Optional:
pvd titanium black (.TB); gold (.TG) /
copper (.TCO); / natural (.TN)

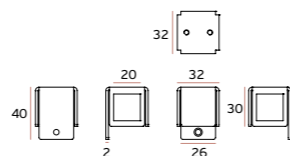

SM.042.B SM.042.F

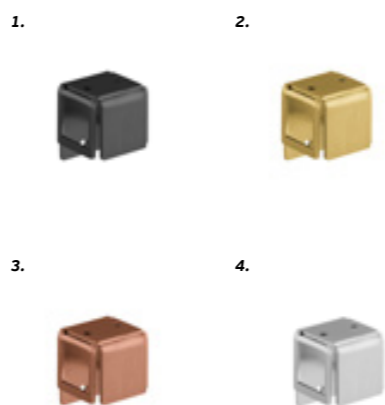

1. SM.063.TB 2. SM.063.TG
3. SM.063.TCO 4. SM.063.TN

SM.064.D
Suporte superior para painel /
Upper panel holder /
Soporte superior para panel.

Material: EN 1.4301 / AISI 304
Acabamento / Finish / Acabado:
satinado / satin
Opcional / Optional:
pvd titanium black (.TB); gold (.TG) /
copper (.TCO); / natural (.TN)

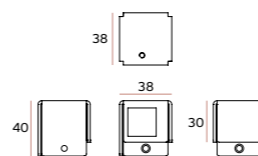

SM.042.B SM.042.F



1. SM.064.D.TB 2. SM.064.D.TG
3. SM.064.D.TCO 4. SM.064.D.TN

SM.064.E
Suporte superior para painel /
Upper panel holder /
Soporte superior para panel.

Material: EN 1.4301 / AISI 304
Acabamento / Finish / Acabado:
satinado / satin
Opcional / Optional:
pvd titanium black (.TB); gold (.TG) /
copper (.TCO); / natural (.TN)

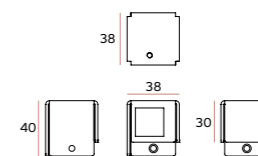

SM.042.B SM.042.F



1. SM.064.E.TB 2. SM.064.E.TG
3. SM.064.E.TCO 4. SM.064.E.TN



SUPORTES PARA FIXAÇÃO DE PAINÉIS HPL / SUPPORTS FOR FIXING HPL PANELS / SOPORTES PARA FIJACIÓN DE PANELES HPL /

SM.061

Suporte para painel /
Panel holder /
Soporte para panel.

Material: EN 1.4301 / AISI 304
Acabamento / Finish / Acabado:
satinado / satin
Opcional / Optional:
pvd titanium black (.TB); gold (.TG) /
copper (.TCO); / natural (.TN)

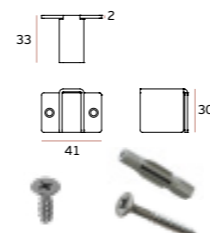

SM.042.A SM.042.E



1.



2.



3.



4.



1. SM.061.TB
3. SM.061.TCO

2. SM.061.TG
4. SM.061.TN

SM.065

Suporte para painel /
Panel holder /
Soporte para panel.

Material: EN 1.4301 / AISI 304
Acabamento / Finish / Acabado:
satinado / satin
Opcional / Optional:
pvd titanium black (.TB); gold (.TG) /
copper (.TCO); / natural (.TN)

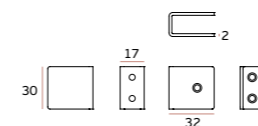

SM.042.A SM.042.E



1.



2.



3.



4.



1. SM.065.TB
3. SM.065.TCO

2. SM.065.TG
4. SM.065.TN

SM.024

Suporte para painel /
Panel holder / Soporte para panel.

Material: EN 1.4301 / AISI 304
Acabamento / Finish / Acabado:
satinado / satin
Opcional / Optional:
pvd titanium black (.TB); gold (.TG) /
copper (.TCO); / natural (.TN)

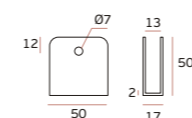

SM.040 SM.041 SM.042.E



1.



2.



3.



4.



1. SM.024.TB
3. SM.024.TCO

2. SM.024.TG
4. SM.024.TN

SUPORTES PARA FIXAÇÃO DE PAINÉIS HPL / SUPPORTS FOR FIXING HPL PANELS / SOPORTES PARA FIJACIÓN DE PANELES HPL /

SM.004

Suporte para painel /
Panel holder / Soporte para panel.

Material: EN 1.4301 / AISI 304
Acabamento / Finish / Acabado:
satinado / satin
Opcional / Optional:
pvd titanium black (.TB); gold (.TG) /
copper (.TCO); / natural (.TN)

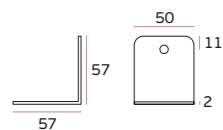

SM.040 SM.041 SM.042.B SM.042.F

SM.014

Suporte para painel /
Panel holder / Soporte para panel.

Material: EN 1.4301 / AISI 304
Acabamento / Finish / Acabado:
satinado / satin
Opcional / Optional:
pvd titanium black (.TB); gold (.TG) /
copper (.TCO); / natural (.TN)

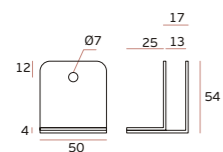

SM.040 SM.041 SM.042.B SM.042.F

SM.034

Suporte para painel /
Panel holder / Soporte para panel.

Material: EN 1.4301 / AISI 304
Acabamento / Finish / Acabado:
satinado / satin
Opcional / Optional:
pvd titanium black (.TB); gold (.TG) /
copper (.TCO); / natural (.TN)

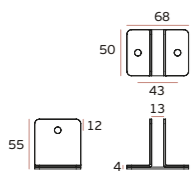

SM.040 SM.041 SM.042.B SM.042.F

1.



1. SM.004.TB
3. SM.004.TCO

2.



2. SM.004.TG
4. SM.004.TN

3.



4.



SM.101

Perfil em "U" para painel de
13mm / "U" shape profile for
13mm panel / Perfil en "U" para
panel de 13mm.

Material: EN 1.4301 / AISI 304
Acabamento / Finish / Acabado:
satinado / satin

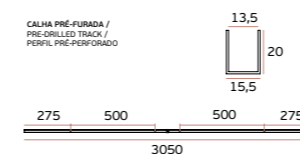

SM.102

Perfil em "U" para painel de
10mm / "U" shape profile for
10mm panel / Perfil en "U" para
panel de 10mm.

Material: EN 1.4301 / AISI 304
Acabamento / Finish / Acabado:
satinado / satin

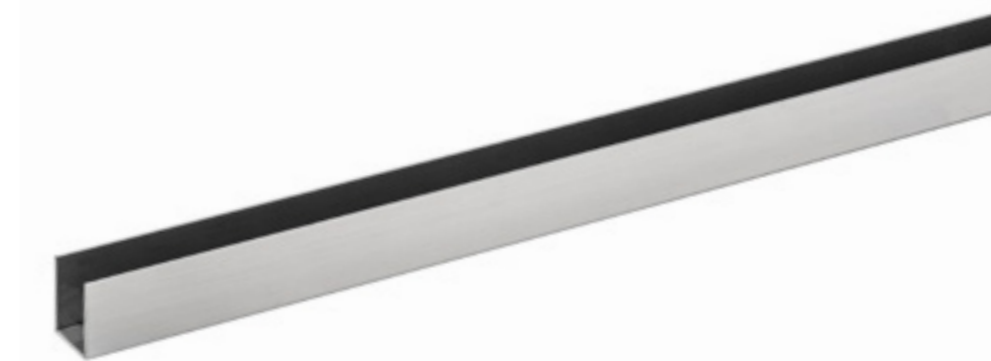
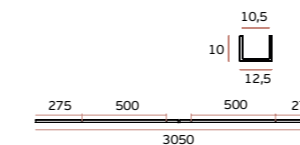

SM.103

Perfil em "U" para painel de
13mm / "U" shape profile for
13mm panel / Perfil en "U" para
panel de 13mm.

Material: alumínio / aluminium
Acabamento / Finish / Acabado:
satinado / satin

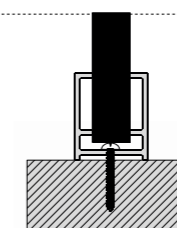
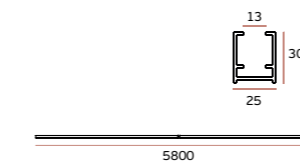

SISTEMA COMPLETO DE PORTA DE CORRER EM PAINEL HPL / COMPLETE SLIDING DOOR SYSTEM FOR HPL DOORS / SISTEMA COMPLETO PARA PUERTAS CORREDERAS EN HPL.



IN.15.258

Sistema completo de porta de correr para cabines em HPL
Inclui:

Calha de alumínio 2900mm (pode ser cortada)
(x2) Roldanas com suporte para fenólico /
(x2) Suportes de parede /
(x1) Guia inferior para fenólico /

Espessuras de fenólico: 10-13mm.
Largura máx. da porta: 1500mm
Peso máx. da porta: 60kg

(Porta, puxador e fechadura não incluídos)

Complete sliding door system
for HPL cabinets
Includes:

Aluminium track 2900mm (can be cutted) /
(x2) Wheels with phenolic support /
(x2) Wall supports /
(x1) Lower guide to phenolic /

Phenolic thickness: 10-13mm.
Max. door length: 1500mm
Max. door weight: 60kg

(Door, handle and lock not included)

Sistema completo para puertas correderas para cabinas en HPL
incluso:

Guia en aluminio 2900mm (puede ser cortada).
(x2) Ruedas con soporte para fenólico.
(x2) Soportes de pared.
(x1) Guia de bajo para fenólico.

Espesor de lo fenólico: 10-13mm.
Anchura max. de la puerta: 1500mm
Peso max. de la puerta: 60kg

(Puerta, manilla y cerradura no incluidas)

