



J



**SINALÉTICA,  
NÚMEROS E LETRAS /**  
PICTOGRAMS, NUMBERS  
AND LETTERS /  
SEÑALIZACIÓN,  
NÚMEROS Y LETRAS.

# SINALÉTICA / PICTOGRAMS / SEÑALIZACIÓN



IMAGEM / IMAGE:  
IN.26.941+ IN.26.939.D



IMAGEM / IMAGE:  
IN.26.903



IMAGEM / IMAGE:  
IN.26.941+ IN.26.939.D

**IN.26.9**  
**Pictogramas com suporte em abs e fixações ocultas (placa simples) /**  
*Pictograms with abs support and concealed fixing (single plate) /*  
*Pictogramas con el apoyo en abs y fijación oculta (placa simple).*

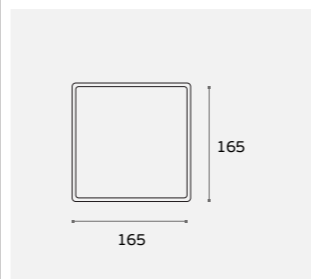

**MATERIAL:** EN 1.4301 / AISI 304  
**ACABAMENTO / FINISH / ACABADO STANDARD:** SATINADO / SATIN  
**MATERIAL:** VINIL PRETO / BLACK VINYL  
**DESIGN:** CHRISTIAN MAGALHÃES

**IN.26.9 (+) IN.26.9 .D**  
**Pictogramas com suporte em abs e fixações ocultas (placa dupla) /**  
*Pictograms with abs support and concealed fixing (double plate) /*  
*Pictogramas con el apoyo en abs y fijación oculta (placa doble).*

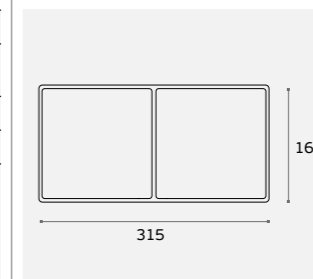

**MATERIAL:** EN 1.4301 / AISI 304  
**ACABAMENTO / FINISH / ACABADO STANDARD:** SATINADO / SATIN  
**MATERIAL:** VINIL PRETO / BLACK VINYL  
**DESIGN:** CHRISTIAN MAGALHÃES

- |     |     |     |     |     |     |     |     |     |     |     |
|-----|-----|-----|-----|-----|-----|-----|-----|-----|-----|-----|
|     |     |     |     |     |     |     |     |     |     |     |
| 901 | 902 | 903 | 904 | 905 | 906 | 907 | 908 | 909 | 910 | 911 |
|     |     |     |     |     |     |     |     |     |     |     |
| 912 | 913 | 914 | 915 | 916 | 917 | 918 | 919 | 920 | 921 | 922 |
|     |     |     |     |     |     |     |     |     |     |     |
| 923 | 924 | 925 | 926 | 927 | 928 | 929 | 930 | 931 | 932 | 933 |
|     |     |     |     |     |     |     |     |     |     |     |
| 934 | 935 | 936 | 937 | 938 | 939 | 940 | 941 | 942 |     |     |



# SINALÉTICA / PICTOGRAMS / SEÑALIZACIÓN

## MÚLTIPLAS SOLUÇÕES / MULTIPLE SOLUTIONS / MÚLTIPLES SOLUCIONES.



Exemplo / Example / Ejemplo  
IN.26.910

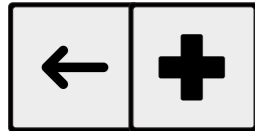

Exemplo / Example / Ejemplo  
IN.26.914 (+) IN.26.915.D



Exemplo / Example / Ejemplo  
IN.26.909 (+) IN.26.908.D / IN.26.914

## HORIZONTAL OU VERTICAL / HORIZONTAL OR VERTICAL

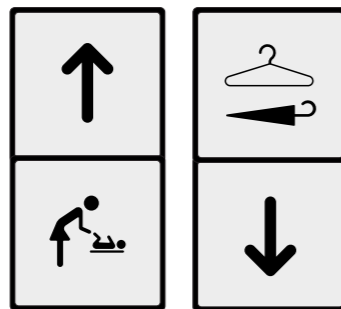
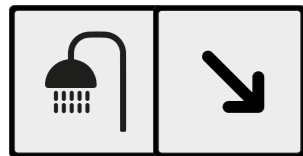
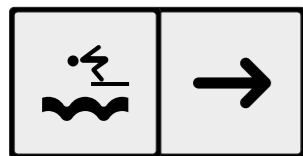

SUPORTE EM ABS /  
ABS SUPPORT /  
SOPORTE EM ABS.

FIXAÇÃO OCULTA POR PARAFUSO /  
HIDDEN FIXING BY SCREW /  
FIJACIÓN OCULTA MEDIANTE TORNILLO

**Ambas as placas (simples ou dupla) são fornecidas com adesivo 3M extra forte e parafusos para montagem na parede /**

*Both plates (single or double) are supplied with extra strong 3M adhesive and screws for wall mount /*

*Ambos placas (sencillos o dobles) se suministran con adhesivo 3M extra fuerte y tornillos para montaje en pared /*

ADESIVO 3M EXTRA FORTE /  
EXTRA STRONG 3M ADHESIVE /  
ADHESIVO 3M EXTRA FUERTE.

EN 1.4301/ AISI 304  
SATINADO / SATIN

VINIL PRETO MATE /  
BLACK MATTE VINYL /  
VINOLO NEGRO MATE



# SINALÉTICA / PICTOGRAMS / SEÑALIZACIÓN

## IN.26.6\_\_ EVOL

Pictogramas aplicados em aço inox de 1,5mm para aplicação paralela à parede. Fornecido com suporte de parede em aço inoxidável /

Stainless steel pictograms with 1,5mm thickness for application parallel to the wall. Supplied with stainless steel wall support /

Sinalética en acero inox de 1,5mm para uso paralelo a la pared. Suministrado con soporte de pared en acero inoxidable.



IMAGEM / IMAGE:  
IN.26.601

MATERIAL: EN 1.4301 / AISI 304 + VINIL PRETO / BLACK VINYL / VÍNILO NEGRO

ACABAMENTO / FINISH / ACABADO: STANDARD: SATINADO / SATIN / SATIN

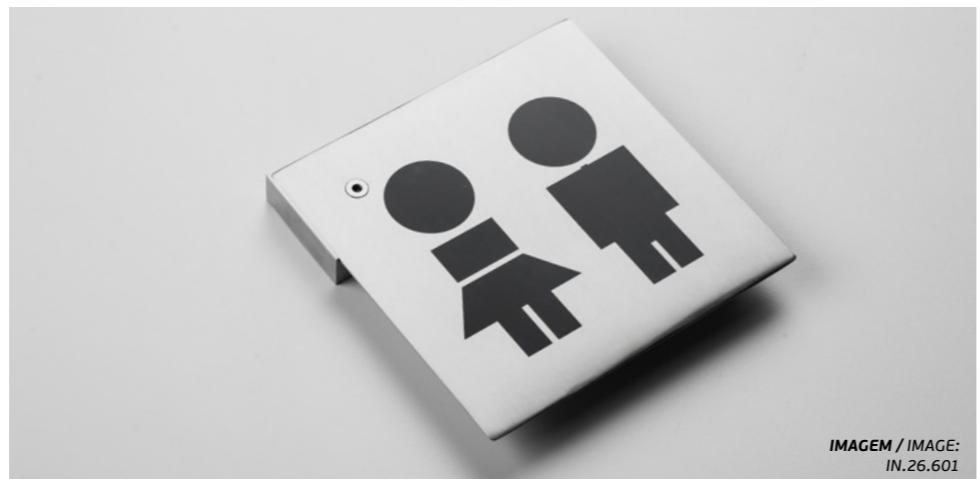
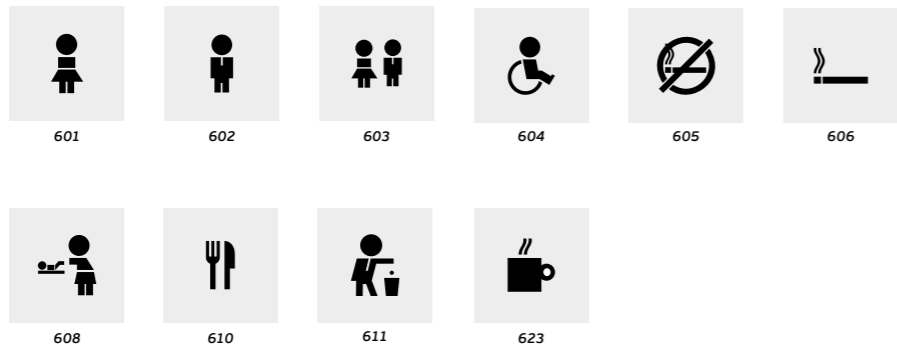
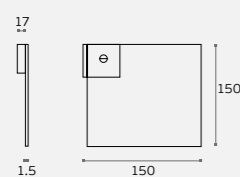

NEW

## IN.26.7\_\_

Pictogramas aplicados em aço inox de 1,5mm para aplicação paralela à parede. Fornecido com suporte de parede em aço inoxidável /

Stainless steel pictograms with 1,5mm thickness for application parallel to the wall. Supplied with stainless steel wall support /

Sinalética en acero inox de 1,5mm para uso paralelo a la pared. Suministrado con soporte de pared en acero inoxidable.



IMAGEM / IMAGE:  
IN.26.708

MATERIAL: EN 1.4301 / AISI 304 + VINIL PRETO / BLACK VINYL / VÍNILO NEGRO

ACABAMENTO / FINISH / ACABADO: STANDARD: SATINADO / SATIN / SATIN

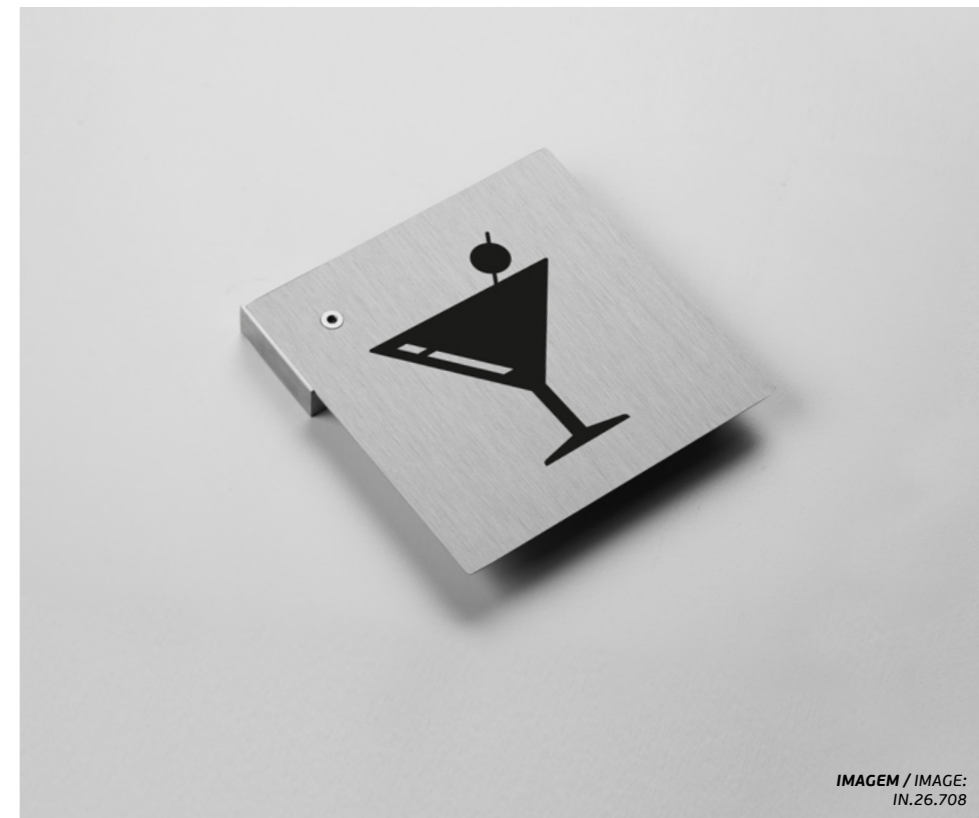

## IN.26.8\_\_ EVOL

Pictogramas aplicados em aço inox de 1,5mm para aplicação paralela à parede. Com fixação por adesivo extra-forte.

Stainless steel pictograms with 1,5mm thickness for application parallel to the wall. Strong adhesive fixing.

Sinalética en acero inox de 1,5mm para uso paralelo a la pared. Con sujeción por adhesivo extra-fuerte.



IMAGEM / IMAGE:  
IN.26.801 + IN.26.802

MATERIAL: EN 1.4301 / AISI 304 + VINIL PRETO / BLACK VINYL / VÍNILO NEGRO

ACABAMENTO / FINISH / ACABADO: STANDARD: SATINADO / SATIN / SATIN

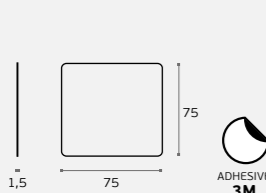



# SINALÉTICA / PICTOGRAMS / SEÑALIZACIÓN



## IN.26.2\_\_

Pictogramas aplicados em aço inox de 1,5mm para aplicação paralela à parede. Com fixação por adesivo extra-forte.

Stainless steel pictograms with 1,5mm thickness for application parallel to the wall. Strong adhesive fixing.

Sinalética en acero inox de 1,5mm para uso paralelo a la pared. Con sujeción por adhesivo extra-fuerte.

MATERIAL: EN 1.4301 / AISI 304 + VINIL PRETO / BLACK VINYL / VINILO NEGRO

ACABAMENTO / FINISH / ACABADO: STANDARD: SATINADO / SATIN / SATIN

DESIGN: PEDRO SOUSA



IMAGEM / IMAGE: IN.26.235 + IN.26.242



# SINALÉTICA / PICTOGRAMS / SEÑALIZACIÓN

**IN.26.4\_\_P**  
Pictogramas com fixação por parafusos / Pictograms with fixing system through screws / Sinalética con sujeción por tornillos.

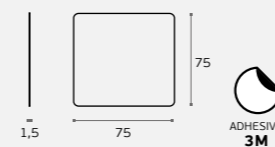
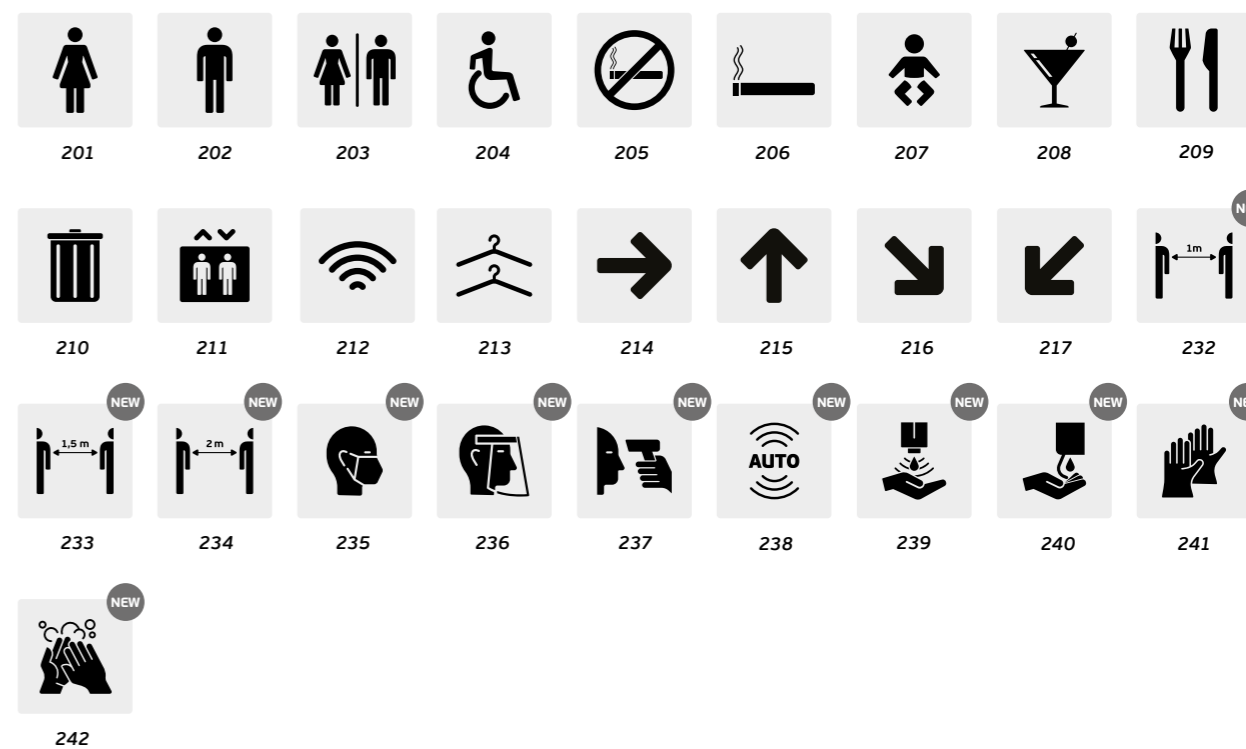
**MATERIAL:** EN 1.4301 / AISI 304  
**ACABAMENTO / FINISH / ACABADO:** STANDARD: SATINADO / SATIN / SATIN



IMAGEM / IMAGE: IN.26.403.P

**IN.26.4\_\_A**  
Pictogramas com fixação por adesivo extra-forte / Pictograms with strong adhesive fixing / Sinalética con sujeción por adhesivo extra-fuerte.

**MATERIAL:** EN 1.4301 / AISI 304  
**ACABAMENTO / FINISH / ACABADO:** STANDARD: SATINADO / SATIN / SATIN

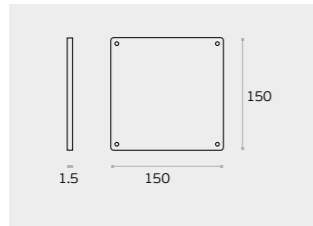

IMAGEM / IMAGE: IN.26.403.A

**IN.26.4\_\_S**  
Pictogramas com suporte para parede / Pictograms with wall mounting support / Sinalética con soporte a pared.

**MATERIAL:** EN 1.4301 / AISI 304  
**ACABAMENTO / FINISH / ACABADO:** STANDARD: SATINADO / SATIN / SATIN

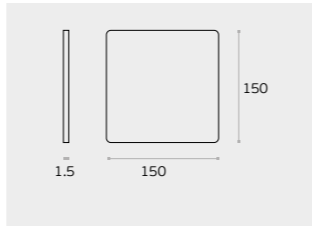

IMAGEM / IMAGE: IN.26.401.S

- |     |     |     |     |
|-----|-----|-----|-----|
|     |     |     |     |
| 401 | 402 | 403 | 404 |
|     |     |     |     |
| 405 | 406 | 407 | 408 |
|     |     |     |     |
| 409 | 410 | 413 | 414 |
|     |     |     |     |
| 423 | 424 | 425 |     |



IMAGEM / IMAGE: IN.26.401.S

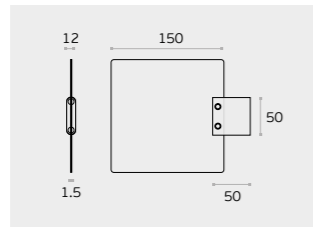

# SINALÉTICA / PICTOGRAMS / SEÑALIZACIÓN

IN.26.5\_..B  
IN.26.5\_..M

Vinil aplicado em vidro temperado transparente. Fornecido com Suportes de parede em aço inoxidável /

Vinyl applied in tempered transparent glass. Supplied with stainless steel wall supports /

Vinil aplicado en cristal templado transparente. Suministrado con soportes de pared en acero inoxidable.

MATERIAL:  
VIDRO / GLASS / CRISTAL + VINYL

(.B) PRETO / BLACK / NEGRO

(.M) CINZENTO / GREY / GRIS



IMAGEM / IMAGE:  
IN.26.505.B



IMAGEM / IMAGE:  
IN.26.411 + IN.26.412  
IN.26.415.P + IN.26.416.P

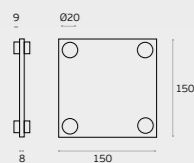

# SINALÉTICA / PICTOGRAMS / SEÑALIZACIÓN



**IN.26.411**  
*Silhuetas para casa de banho com fixação por adesivo /  
Bathroom indicators with strong adhesive fixing /  
Indicadores de baño con sujeción por adhesivo extra fuerte.*

**MATERIAL:** EN 1.4301 / AISI 304  
**ACABAMENTO / FINISH / ACABADO:**  
**STANDARD:** SATINADO / SATIN / SATIN

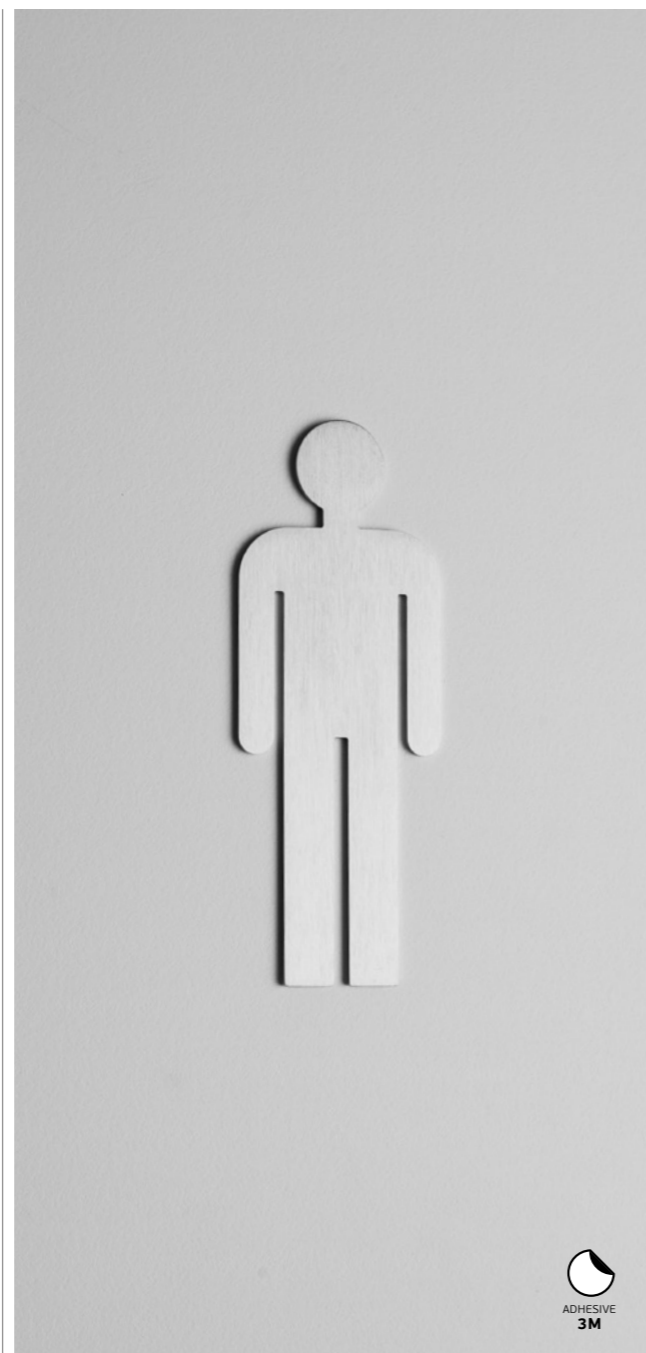
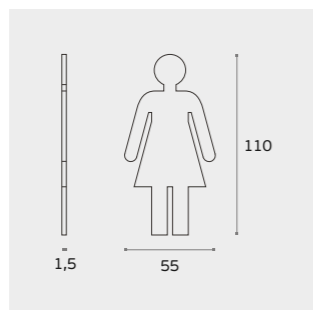

**IN.26.412**  
*Silhuetas para casa de banho com fixação por adesivo /  
Bathroom indicators with strong adhesive fixing /  
Indicadores de baño con sujeción por adhesivo extra fuerte.*

**MATERIAL:** EN 1.4301 / AISI 304  
**ACABAMENTO / FINISH / ACABADO:**  
**STANDARD:** SATINADO / SATIN / SATIN

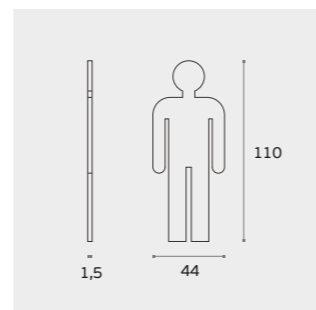

**IN.26.415.P**  
*Silhuetas para casa de banho com fixação oculta por parafuso /  
Bathroom indicators with concealed fixing at the wall /  
Indicadores de toilette con sujeción oculta por tornillos.*

**MATERIAL:** EN 1.4301 / AISI 304  
**ACABAMENTO / FINISH / ACABADO:**  
**STANDARD:** SATINADO / SATIN / SATIN

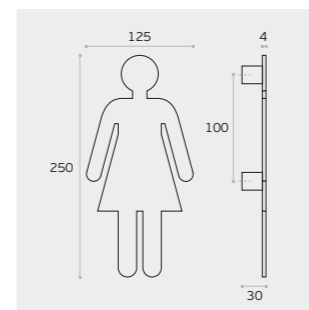

**IN.26.416.P**  
*Silhuetas para casa de banho com fixação oculta por parafuso /  
Bathroom indicators with concealed fixing at the wall /  
Indicadores de toilette con sujeción oculta por tornillos.*

**MATERIAL:** EN 1.4301 / AISI 304  
**ACABAMENTO / FINISH / ACABADO:**  
**STANDARD:** SATINADO / SATIN / SATIN

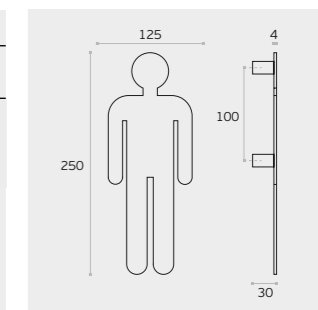



# SINALÉTICA / PICTOGRAMS / SEÑALIZACIÓN

## IN.34.300.\_

Letras e números aplicados em aço inox de 1,5mm para aplicação paralela à parede. Com fixação por adesivo extra-forte.

Stainless steel Letters and numbers with 1,5mm thickness for application parallel to the wall. Strong adhesive fixing.

Letras y numeros en acero inox de 1,5mm para uso paralelo a la pared. Con sujeción por adhesivo extra-fuerte.



IMAGEM / IMAGE:  
IN.34.300.8 + IN.34.300.4

MATERIAL: EN 1.4301 / AISI 304 + VINIL PRETO / BLACK VINYL / VINOLO NEGRO

ACABAMENTO / FINISH / ACABADO: STANDARD: SATINADO / SATIN / SATIN

DESIGN: PEDRO SOUSA

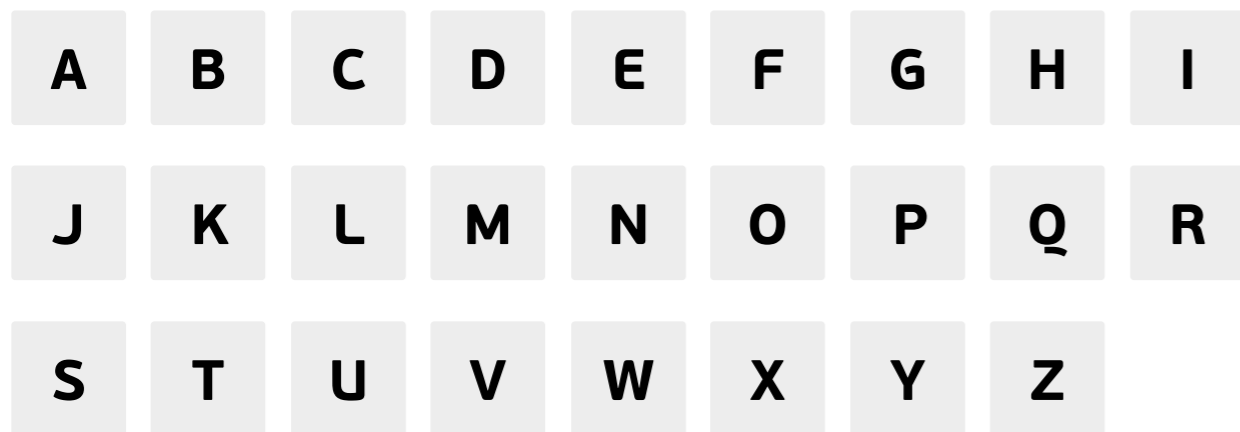
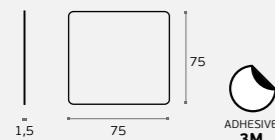

### Exemplo / Example / Ejemplo

A - IN.34.300.R + IN.34.300.O + IN.34.300.O + IN.34.300.M

B - IN.34.300.2 + IN.34.300.5 + IN.34.300.8

C - IN.26.208 + IN.26.212



MÚLTIPLAS SOLUÇÕES /  
MULTIPLE SOLUTIONS / MÚLTIPLES SOLUCIONES



## IN.26.800

Pictogramas em aço inox de 1,5mm para aplicação paralela à parede. Fornecido com suporte de parede em aço inoxidável.

Stainless steel pictograms with 1,5mm thickness for application parallel to the wall. Supplied with stainless steel wall support.

Sinalética en acero inox de 1,5mm para uso paralelo a la pared. Suministrado con soporte de pared en acero inoxidable.

MATERIAL: EN 1.4301 / AISI 304 + VINIL PRETO / BLACK VINYL / VINOLO NEGRO

ACABAMENTO / FINISH / ACABADO: STANDARD: SATINADO / SATIN / SATIN

TIPOGRAFIA / TYPEFONT: STANDARD: ARIAL BLACK

O TEXTO PRETENDIDO DEVE SER ESCRITO APÓS A REFERÊNCIA / THE INTENDED TEXT MUST BE WRITTEN AFTER THE REFERENCE / EL TEXTO PREVISTO SE DEBE ESCRIBIR DESPUÉS DE LA REFERENCIA.

Exemplo / Example / Ejemplo:  
IN.26.800.Showroom



IMAGEM / IMAGE:  
IN.26.800.SHOWROOM

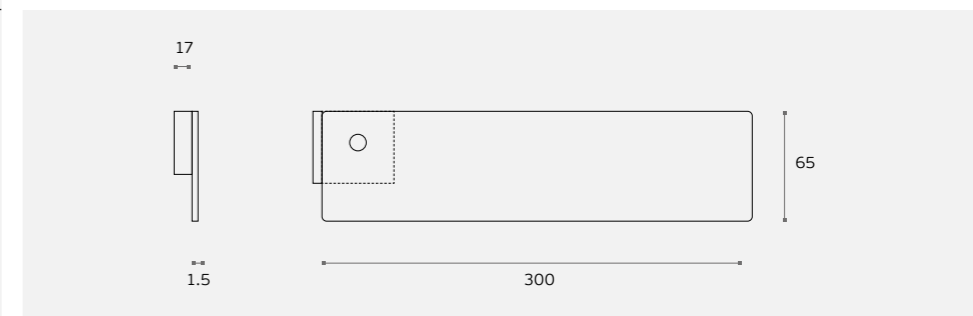



# SINALÉTICA / PICTOGRAMS / SEÑALIZACIÓN



## IN.26.600

Vidro temperado transparente. Fornecido com quatro Suportes de parede em aço inoxidável /

Tempered transparent glass. Supplied with four stainless steel wall supports /

Cristal templado transparente. Suministrado con cuatro soportes de pared en acero inoxidable.

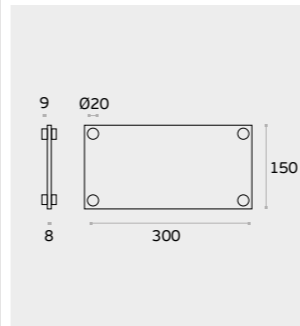

MATERIAL: VIDRO TEMPERADO / TEMPERED GLASS / CRISTAL TEMPLADO

ESPESSURA / THICKNESS: 8MM



## IN.26.600.B

Vinil aplicado em vidro temperado transparente. Fornecido com Suportes de parede em aço inoxidável / Vinyl applied in tempered transparent glass. Supplied with stainless steel wall supports /

Vinil aplicado em vidro temperado transparente. Fornecido com Suportes de parede em aço inoxidável / Vinyl applied in tempered transparent glass. Supplied with stainless steel wall supports /

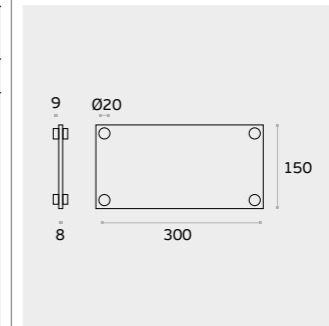

MATERIAL: VIDRO TEMPERADO / TEMPERED GLASS / CRISTAL TEMPLADO

MATERIAL: VINIL / VINYL

(.B) PRETO / BLACK / NEGRO

(.M) CINZENTO / GREY / GRIS

ESPESSURA / THICKNESS: 8MM



## IN.26.700.1 IN.26.700.2

Pictogramas em aço inox de 1,5mm para aplicação paralela à parede com fixação oculta por adesivo extra-forte.

Stainless steel pictograms with 1,5mm thickness for application parallel to the wall. Supplied with concealed fixing through strong adhesive.

Sinalética en acero inox de 1,5mm para uso paralelo a la pared. Suministrado con sujeción oculta por adhesivo extra-fuerte.



IN.26.700.1  
1 linha / 1 line / 1 línea



IN.26.700.2  
2 linhas / 2 lines / 2 líneas

MATERIAL: EN 1.4301 / AISI 304  
ACABAMENTO / FINISH / ACABADO STANDARD: SATINADO / SATIN  
MATERIAL: VINIL PRETO / BLACK VINYL  
TIPOGRAFIA / TYPEFONT STANDARD: PF BEAUSANS BOLD

O TEXTO PRETENDIDO DEVE SER ESCRITO APÓS A REFERÊNCIA /

THE INTENDED TEXT MUST BE WRITTEN AFTER THE REFERENCE /

EL TEXTO PREVISTO SE DEBE ESCRIBIR DESPUÉS DE LA REFERENCIA.

Exemplo / Example / Ejemplo:  
IN.26.700.1.SHOWROOM  
IN.26.700.2.SHOWROOM/MEETING ROOM

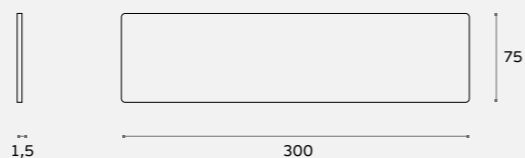

1,5

300

75



## IN.34.102.B

Vinil aplicado em vidro temperado transparente. Fornecido com suportes de parede em aço inoxidável / Vinyl applied in tempered transparent glass. Supplied with stainless steel wall supports /

## IN.34.102.M

Vinil aplicado em vidro temperado transparente. Fornecido com suportes de parede em aço inoxidável / Vinyl applied in tempered transparent glass. Supplied with stainless steel wall supports /



IN.80.250  
EN 1.4301  
Satinado / Satin  
Suportes de vidro com fixação oculta.  
Glass supports with hidden fixing system.  
Soportes de cristal con fijación oculta.

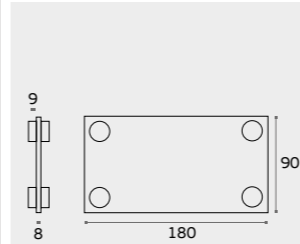
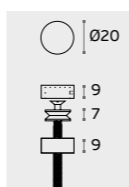

MATERIAL: VIDRO TEMPERADO / TEMPERED GLASS / CRISTAL TEMPLADO

MATERIAL: VINIL / VINYL

(.B) PRETO / BLACK / NEGRO

(.M) CINZENTO / GREY / GRIS

ESPESSURA / THICKNESS: 8MM



## IN.34.100.B

Vinil aplicado em vidro temperado transparente. Fornecido com suportes de parede em aço inoxidável / Vinyl applied in tempered transparent glass. Supplied with stainless steel wall supports /

## IN.34.100.M

Vinil aplicado em vidro temperado transparente. Fornecido com suportes de parede em aço inoxidável / Vinyl applied in tempered transparent glass. Supplied with stainless steel wall supports /

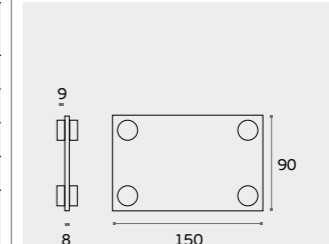

MATERIAL: VIDRO TEMPERADO / TEMPERED GLASS / CRISTAL TEMPLADO

MATERIAL: VINIL / VINYL

(.B) PRETO / BLACK / NEGRO

(.M) CINZENTO / GREY / GRIS

ESPESSURA / THICKNESS: 8MM





# LETRAS / LETTERS / LETRAS

**IN.34.005.P.**  
Letras maiúsculas com fixação oculta por parafusos à parede /  
Uppercase letters with concealed fixing through wall screws /  
Letras mayúsculas con sujeción oculta por tornillo.

.TB .TG .TCO .TCH

MATERIAL: EN 1.4301 / AISI 304

ACABAMENTO / FINISH / ACABADO:  
STANDARD: SATINADO / SATIN / SATIN

IMAGEM / IMAGE / IMAGEN:  
IN.34.005.P.C

3 |  | 10

100 | ABCD...Z



**IN.34.005.A.**  
Letras maiúsculas com fixação oculta por adesivo extra-forte /  
Uppercase letters with concealed fixing through strong adhesive /  
Letras mayúsculas con sujeción oculta por adhesivo extra-fuerte.

MATERIAL: EN 1.4301 / AISI 304

ACABAMENTO / FINISH / ACABADO:  
STANDARD: SATINADO / SATIN / SATIN

IMAGEM / IMAGE / IMAGEN:  
IN.34.005.A.A

2 |  | 10

100 | ABCD...Z



ADHESIVE  
3M

**IN.34.004.P.**  
Letras minúsculas com fixação oculta por parafusos à parede /  
Lowercase alphabets with concealed fixing through wall screws /  
Letras minúsculas con sujeción oculta por tornillo.

.TB .TG .TCO .TCH

MATERIAL: EN 1.4301 / AISI 304

ACABAMENTO / FINISH / ACABADO:  
STANDARD: SATINADO / SATIN / SATIN

IMAGEM / IMAGE / IMAGEN:  
IN.34.004.P.B

3 |  | 10

100 | abcd...z



**IN.34.004.A.**  
Letras minúsculas com fixação oculta por adesivo extra-forte /  
Lowercase alphabets with concealed fixing through strong adhesive /  
Letras minúsculas con sujeción oculta por adhesivo extra-fuerte.

MATERIAL: EN 1.4301 / AISI 304

ACABAMENTO / FINISH / ACABADO:  
STANDARD: SATINADO / SATIN / SATIN

IMAGEM / IMAGE / IMAGEN:  
IN.34.004.A.U

2 |  | 10

100 | abcd...z



ADHESIVE  
3M

NEW

**IN.34.PT.P.**  
Acentos gráficos com fixação oculta por parafusos à parede /  
Graphic accentuation with concealed fixing through strong adhesive /  
Acentuación gráfica con sujeción oculta por adhesivo extra-fuerte.

.TB .TG .TCO .TCH

MATERIAL: EN 1.4301 / AISI 304

ACABAMENTO / FINISH / ACABADO:  
STANDARD: SATINADO / SATIN / SATIN

IMAGEM / IMAGE / IMAGEN:  
IN.34.PT.P.V + IN.34.PT.P.AA



NEW

**IN.34.PT.A.**  
Acentos gráficos com fixação oculta por adesivo extra-forte /  
Graphic accentuation with concealed fixing through strong adhesive /  
Acentuación gráfica con sujeción oculta por adhesivo extra-fuerte.

MATERIAL: EN 1.4301 / AISI 304

ACABAMENTO / FINISH / ACABADO:  
STANDARD: SATINADO / SATIN / SATIN

IMAGEM / IMAGE / IMAGEN:  
IN.34.PT.A.V + IN.34.PT.A.AA



ADHESIVE  
3M



IMAGEM / IMAGE:  
IN.34.002.P.B + IN.34.005.A.P  
+ IN.34.004.A.C + IN.34.004.P.B + IN.34.005.P.E



NÚMEROS /  
NUMBERS / NÚMEROS



**IN.34.003.A.**  
**Algarismos com fixação oculta por adesivo extra-forte /** Numerals with concealed fixing through strong adhesive / Algarismos con sujeción oculta por adhesivo extra-fuerte.

**MATERIAL:** EN 1.4301 / AISI 304

**ACABAMENTO / FINISH / ACABADO:**  
**STANDARD:** SATINADO / SATIN / SATIN

**IMAGEM / IMAGE / IMAGEN:**  
IN.34.003.A.7



100 | 0123456789



**IN.34.000.A.**  
**Algarismos com fixação oculta por adesivo extra-forte /** Numerals with concealed fixing through strong adhesive / Algarismos con sujeción oculta por adhesivo extra-fuerte.

**MATERIAL:** EN 1.4301 / AISI 304

**ACABAMENTO / FINISH / ACABADO:**  
**STANDARD:** SATINADO / SATIN / SATIN

**IMAGEM / IMAGE / IMAGEN:**  
IN.34.000.A.2



150 | 0123456789



**IN.34.003.P.**  
**Algarismos com fixação oculta por parafusos à parede /** Numerals with concealed fixing through wall screws / Algarismos con sujeción oculta por tornillo.



**MATERIAL:** EN 1.4301 / AISI 304

**ACABAMENTO / FINISH / ACABADO:**  
**STANDARD:** SATINADO / SATIN / SATIN

**IMAGEM / IMAGE / IMAGEN:**  
IN.34.003.P.5



100 | 0123456789



**IN.34.000.P.**  
**Algarismos com fixação oculta por parafusos à parede /** Numerals with concealed fixing through wall screws / Algarismos con sujeción oculta por tornillo.



**MATERIAL:** EN 1.4301 / AISI 304

**ACABAMENTO / FINISH / ACABADO:**  
**STANDARD:** SATINADO / SATIN / SATIN

**IMAGEM / IMAGE / IMAGEN:**  
IN.34.000.P.4



150 | 0123456789



**IN.34.002.P.**  
**Algarismos com fixação oculta por parafusos à parede /** Numerals with concealed fixing through wall screws / Algarismos con sujeción oculta por tornillo.



**MATERIAL:** EN 1.4301 / AISI 304

**ACABAMENTO / FINISH / ACABADO:**  
**STANDARD:** SATINADO / SATIN / SATIN

**IMAGEM / IMAGE / IMAGEN:**  
IN.34.002.P.9

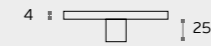

200 | 0123456789

